

TWERD ENERGO-PLUS

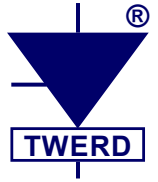

Frequency converter type:

MFC 810

MFC 810 AcR

MFC 1000

MFC 1000 AcR

User Manual

Part II: Software

Software version: 1.98 rev. 57

Document version: 7.4,0

Table of Contents

1. Control panel.....	4
1.1. Blocking parameters.....	8
1.2. Access levels.....	8
1.3. Change of the display values.....	9
1.4. Service menu.....	9
1.4.1. Copying parameter settings via OP-11 control panel.....	9
1.4.2. Copying parameter settings via USB flash drive.....	10
1.4.3. Firmware update.....	10
1.4.4. Faults messages.....	11
2. Configuration of the frequency converter.....	12
2.1. Setting nominal parameters of the motor.....	12
2.1.1. Preparation for operation in a vector control mode.....	12
2.2. Control.....	12
2.2.1. Structure of control.....	12
2.2.2. Control from the control panel.....	14
2.2.3. Control via digital and analog inputs.....	14
2.2.4. Work with constant speeds.....	15
2.2.5. Motopotentiometer.....	15
2.2.6. Other possibilities of the frequency converter control.....	17
2.2.7. Configuration of digital and analog inputs and outputs.....	17
2.3. Configuration of the drive.....	19
2.3.1. Determining the dynamics and method of stopping the drive.....	19
2.3.2. Setting the U/f characteristic.....	20
2.3.3. Elimination of frequencies.....	21
2.3.4. Mechanical brake.....	21
2.3.5. Flying start.....	22
2.4. Protection and blocking.....	22
2.4.1. Current, frequency, torque and power limitations.....	22
2.4.2. Blocking a direction of the motor rotation.....	23
2.4.3. Blocking the drive operation.....	23
2.4.4. Thermal protections of the motor.....	23
3. The first start.....	25
3.1. Vector mode. Identification run.....	25
3.1.1. Stages of identification run.....	25
3.1.2. Switching on identification run.....	25
3.2. Storing and reading of settings for 4 different motors.....	26
4. Failures and warnings.....	27
4.1. Failure messages and warnings on the control panel.....	27
4.2. Deleting failure message. Automatic restarts.....	27
4.2.1. Manual deleting.....	27
4.2.2. Deleting through the digital input of the converter.....	27
4.2.3. Remote deleting through RS link.....	27
4.2.4. Readiness to restart if the cause of failure has not disappeared.....	27
4.3. Failures and warnings codes.....	27
4.4. Failure log.....	27
5. PID controllers.....	29
5.1. Limitation of saturation and SLEEP function.....	29
6. Advanced programming.....	29
6.1. Characteristic Points (PCH).....	29
6.2. PCH and the pointers – how it works.....	30
6.3. Modification of standard control.....	30
7. „Backspin control” - Backspin Control for high-pressure pumping stations (optional).....	31
8. Control of the frequency converter by communications channels.....	33
7.1. Parameters for communication channels.....	34
7.2. Map of registers accessible through communications channels.....	36
7.3. Handling of connection errors.....	37
9. Table of Functions of Universal Blocks.....	38
10. Failures and warnings codes.....	43
11. Characteristic Points PCH.....	51
12. Configuration Parameters.....	59

In this User manual, MFC810, MFC810 AcR, MFC1000, MFC1000 AcR vector frequency converters are also referred to interchangeably as **frequency converters**, **converters**, **drives** and the abbreviation **FC** (frequency converter).

1. Control panel

The control panel (fig. 1.1) is used for:

- monitoring the motor current, voltage, torque, set and output frequency as well as other variables available in the group "0 Preview";
- drive operation control: start, stop, change of the electric motor rotation direction, failure resetting;
- changing the settings of the drive: entering the motor's rated data, start the identification run, selecting the place of control, etc.

The panel is equipped with an LCD display. It is possible to place the panel outside the drive at a distance of not more than 10 m. A suitable cable can be purchased from the drive manufacturer.

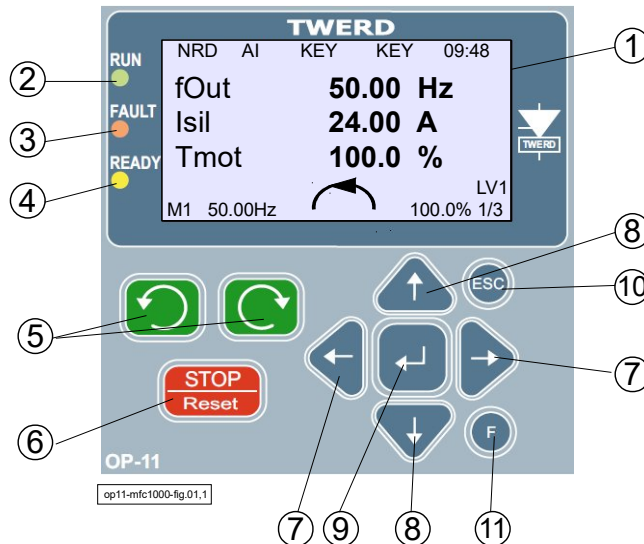

Fig. 1.1. Control panel - general view

The control panel consists of an LCD display (1), LEDs indicating the drive status (2 ÷ 4) and control keys (5 ÷ 11).

LEDs indicating the drive status

RUN (2): drive RUN status

- continuous lighting: drive is running,
- pulsation: issued start command, waiting for the start.

FAULT (3):

- pulsation: alarm (warning)
- continuous lighting: Failure (inverter stopped)

READY (4):

- pulsation: waiting for the power circuit to be activated

Control keys

- 5 – Start Left, Start Right keys (Keyboard control)
- 6 – Stop (Keyboard control) / Removing a fault (press for 3 seconds)
- 7 – switching parameter groups
- 8 – increase / decrease parameter number / value
- 9 – approval
- 10 – resignation
- 11 – function key

After switching on the converter to mains, the control panel is switched on in the MAIN SCREEN as it is shown in fig. 1.2.

Use the arrows ← → to switch to Parameters mode and Preview mode. The control status bar is displayed at the top of the screen at all times. In the lower part of the screen there is a bar informing about the condition of the motor and access level LV.

Control status bar:

- 1 – operating status of the frequency converter – see tab. 1.3
- 2 – place of control
- 3 – frequency reference – see tab. 1.1
- 4 – the source of START / STOP signal – see tab. 1.2
- 5 – time

The customized preview area of variables

- 6 – customized first line
- 7 – customized second line
- 8 – customized third line
- 9 – screen number / number of screens

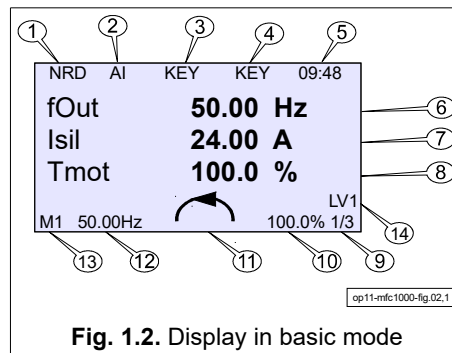

Fig. 1.2. Display in basic mode

Drive status bar:

- 10 – load
- 11 –direction of operation
- 12 – output frequency
- 13 – selected set of the motor parameters
- 14 – access level

Figure 1.3 shows the operation signalling within limits. The blackened background of the number indicates the limited operation.

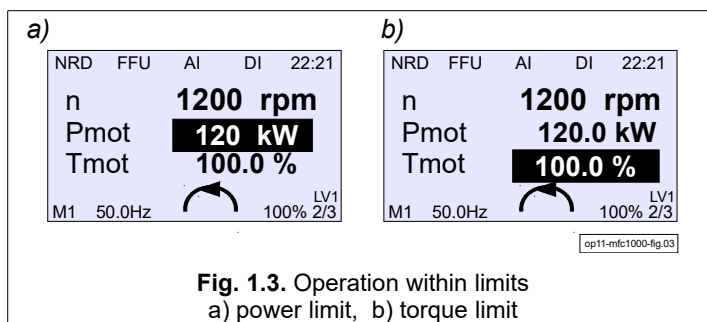

Fig. 1.3. Operation within limits
a) power limit, b) torque limit

The procedure for setting the drive parameters is shown in fig. 1.4. Logic of control places (2) is described in the chapter 2.2. Control on page 12.

Table 1.1. Frequency reference

Displayed name	Description
KEY	Keyboard
MOT1, MOT2, MOT3, MOT4	Motopotentiometer 1..4
PID1, PID2, PID3, PID4	PID 1..4
RS	Connector RS-485
A0, A1, A2, A3, A4	Analog input 0..4
OTH	Custom frequency reference
A11, A12, A21, A22, A31, A32, A41, A42, A51, A52	Analog input 11, 12, 21 ... 52
FC15	Constant frequency 15
AVG	Average frequency of the last 10 seconds
FC1, FC2, ..., FC15	Constant frequency 1..15.

Table 1.2. The source of the signal START/STOP

Displayed name	Description
KEY	Keyboard
RS	Connector RS-485
REM1, REM2, REM3, REM4	Remote referencing-unit 1..4

Table 1.3. Operating status of the frequency converter

No	Displayed name	Description
0	NRD	Drive is no ready
1	PRCH	Precharging
2	RDY	Ready to Start
3	EXC	Excitation
4	FLY	Flying start
5	DREF	Referencing-unit delay
6	ACC	Acceleration to the reference speed
7	STLL	Stall
8	SR	Speed adjustable operation
9	TR	Torque control operation
10	OvT	Active torque limit
11	OvP	Active power limit
12	SRE	Operation with de-excitation of the speed controller
13	TRE	Operation with de-excitation of the torque controller
14	DEC	Deceleration to reference speed
15	REV	Changing the direction of rotation
16	DECS	Deceleration after receiving a STOP command
17	DECB	Deceleration after receiving a STOP Backspin Control
18	BSC1	Deceleration to Backspin Control speed
19	BSC	Backspin Control operation
20	BSCE	Return to the reference speed after the voltage returns - during work in the Backspin Control mode
21	DCbr	DC breaking
22	-	-
23	RES	Reboot after failure
24	-	-
25	Ovl	Current Limit active
26	ErrV	VSD module failure
27	ErrA	AcR module failure
28	ErrC	PCB mfc1000/11 controller failure
29	IDM1	Identification run – stage 1
30	IDM2	Identification run – stage 2
31	IDM3	Identification run – stage 3

1.1. Blocking parameters

Blocking of changes in the drive parameter settings

For that reason, par. **40.01** „*Par. block*” has to be set to **001** „Yes”. Then, it will only be possible to read the parameters (except for par. **40.01**). Setting up par. 40.01 again to 000 "No" will unlock the possibility of changing parameter settings.

1.2. Access levels

Access to drive configuration parameters is restricted by access levels. Each of the converter configuration parameters is assigned from one of these levels and modification of a given parameter is possible only after logging in to the appropriate access level. The padlock symbol next to a given parameter means that it cannot be modified due to the access level being too low.

Access levels:

- Level 0 – no possibility to change the settings of configuration parameters – read access only,
- Level 1 – basic configuration parameters,
- Level 2 – NC RfG network parameters (group 18),
- Level 3 – service parameters (group 97, 98).

Logging in to a given access level is done by pressing the Enter „↵” key on the main screen of the control panel and selecting "Login" - Fig. 1.5.

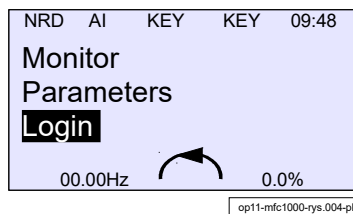

Fig. 1.5. Access levels

Logging into a higher level gives access to parameters from a lower level, e.g. logging into level 2 gives access to parameters from levels 2 and 1. By default, level 1 is protected with the password "00000", which means no security and gives the user access to parameters from this level without having to log in.

The factory access codes can be freely modified by the user using the following parameters:

- par. **40.16** "Level 1 Code" - access code to level 1, default "00000",
- par. **40.17** "Level 2 Code" - access code to level 2, only for installers,
- par. **40.18** "Level 3 Code" - access code to level 3, only for installers.

Changing the access code to level 1 (par. **40.16**) is possible after prior logging in with the access code from level 1, 2 or 3.

Changing the access code to level 2 (par. **40.17**) is possible after prior logging in with the access code from level 2 or 3. Changing the access code to level 3 (par. **40.18**) is possible after prior logging in with the access code from level 3.

The changed access codes aren't visible and cannot be read. It is only possible to reset them to default values using the PUK codes. The level 1 PUK code is included with the inverter (fig. 1.6). To obtain a PUK code for levels 2 and 3, please contact the service.

Resetting the access code to level 1 with the PUK code will activate the access security level 1 and set this access code to "12321".

In order to enable automatic login to access level 1 without having to enter the password, in par. **40.16** the access code should be set to "00000".

Logging out of the current access level takes place after a power reset or when the access code is entered incorrectly. Setting the level 1 access code (par. **40.16**) to "00000" will automatically log into level 1 every time the drive is started; this function does not work for levels 2 and 3.



 <small>Made in Poland</small>	TWERD ENERGO-PLUS Sp. z o.o. ul. Aleksandrowska 28-30 87-100 Toruń, Poland Tel. +48 56 654 60 91	 twerd@twerd.pl www.twerd.pl	ISO 9001
	Serial No. MAC Address Service Code PUK1 Code PUK2 Code Contact Service PUK3 Code Contact Service		

Fig. 1.6. Plate with PUK codes

Logging in can be done from the control panel or remotely via the Modbus protocol at the address 44002. After entering an incorrect code, the login is blocked for 10 seconds, each subsequent incorrect login extends the time by another 10 seconds.

1.3. Change of the display values

The change of values displayed on the main screen is freely configurable by means of the parameters in the group 41 Screen.

1.4. Service menu

The service menu allows you to:

- copy parameters settings between drives via the OP-11 control panel or USB flash drive;
- set the current date and time;
- update the frequency converter firmware.

The USB port is located on PCB mfc1000/11 communication module.

To enter the service menu, press and hold the function button "F" for 5 seconds - (11) in Fig. 1.1. Control panel - general view. The service menu view is shown in the Fig. 1.7.

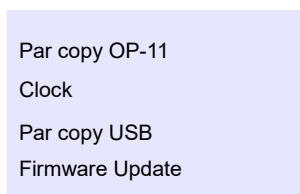

Fig. 1.7. The view of the Service menu

1.4.1. Copying parameter settings via OP-11 control panel

The control panel has a built-in memory and allows you to store 3 sets of settings (SET 1, SET 2, SET 3) of all parameters of the frequency converter in order to upload them later to the same or another frequency converter of the same type.

Copying parameter settings from the frequency converter to the OP-11 control panel:

- press and hold the function button "F" for 5 seconds,
- select **"Par copy OP-11"** and confirm with the Enter key "↵",
- select **"Read from inverter"** and confirm with the Enter key "↵",
- select one of the 3 sets of settings **SET 1, SET 2, SET 3**, to which the parameters will be saved, and confirm with the "↵" Enter key.

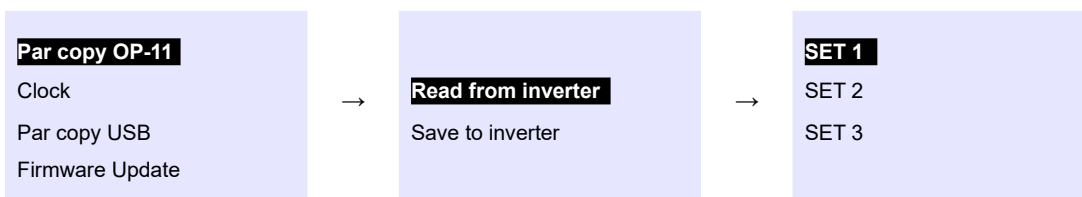

Fig. 1.8. Copying parameters settings: Frequency converter → Control panel

Copying parameter settings from the OP-11 control panel to the frequency converter:

NOTE 1: The frequency converter must be stopped (STOP state) when loading parameter settings.

NOTE 2: Before starting the upload, make sure that the START command is not given from the terminal block or through any of the communication protocols.

In order to write the parameter settings to the frequency converter:

- press and hold the function button "F" for 5 seconds,
- select **"Par copy OP-11"** and confirm with the Enter key "↵",
- select **"Save to inverter"** and confirm with the Enter key "↵",
- select one of the 3 sets of settings **SET 1, SET 2, SET 3**, to which the parameters will be saved, and confirm with the Enter key "↵".

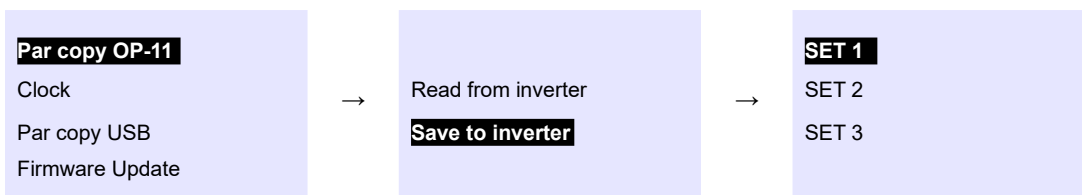

Fig. 1.9. Copying parameters settings: Control panel → Frequency converter

1.4.2. Copying parameter settings via USB flash drive

Any USB flash drive formatted in the FAT32 file system can store up to 30 sets of parameter settings. Parameters settings have a predefined name MFC1000_xx.twrd, where xx is a number from 01 to 30.

The USB flash drive should be empty due to the potential loss of data stored on it.

Copying parameters settings from the frequency converter to a USB flash drive

- press and hold the function button “F” for 5 seconds,
- select **"Par copy USB"** and confirm with the Enter key "↵",
- select **"Inverter → USB"** and confirm with the Enter key "↵",
- select one of the 30 sets of settings from MFC1000_01 to MFC1000_30, to which the parameters will be saved, and confirm **"Save New"** with the Enter key "↵".

If the selected set of settings is already used, the message **"Overwrite"** will appear. Then hold down the Enter key "↵" for a few seconds to overwrite. The parameters will be saved on the USB flash drive as "MFC1000_xx.twrd". **Do not modify the file name!**

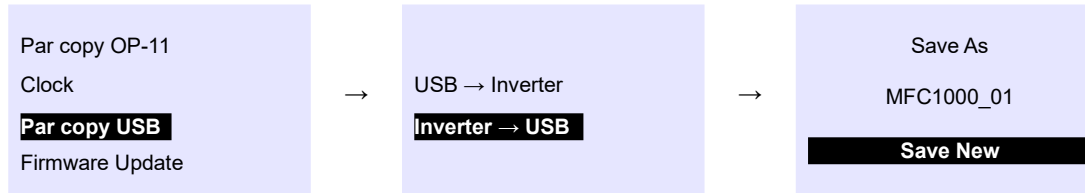

Fig. 1.10. Copying parameters settings: Frequency converter → USB flash drive

Copying Parameters from USB flash drive to frequency converter

NOTE 1: The frequency converter must be stopped (STOP state) while the settings are being loaded.

NOTE 2: Before starting the upload, make sure that the START command is not given from the terminal block or through any of the communication protocols.

In order to save a set of settings to the converter:

- press and hold the function button “F” for 5 seconds - (4) in Fig. 1.1. Control panel - general view,
- select **"Par copy USB"** and confirm with the Enter key "↵",
- select **"USB → Inverter"** and confirm with the Enter key "↵",
- select one set of MFC1000_01..MFC1000_30 settings, from which the previously saved parameters will be downloaded, and confirm **"Load File"** with the Enter key "↵".

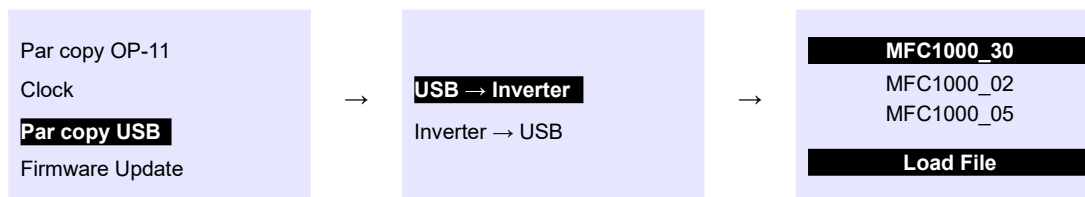

Fig. 1.11. Copying parameters settings: USB flash drive → Frequency converter

1.4.3. Firmware update

The USB flash drive with the firmware update file must be formatted in the FAT32 file system. There should be no other data on it. The firmware update file must have its original name.

It is possible to update the firmware for three different frequency converter modules:

- Control Board – mfc1000/11 communication module,
- ACR Board – ACR module,
- VSD Board – VSD module.

Update process:

1. Connect the USB flash drive to the frequency converter, then press and hold the function button “F” for 5 seconds.
2. Select **"Firmware Update"** and then the module to update.

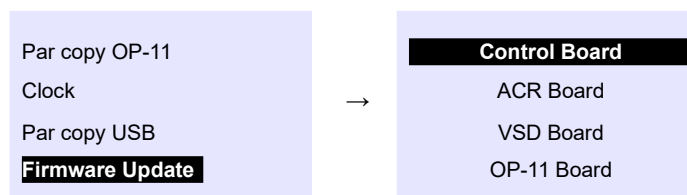

Fig. 1.12. Firmware update - selecting the module to be updated

3. When you select the module to update, a summary with the current and new version program number will appear on the screen. Confirm **“Start Updating”** by pressing Enter "↵" to start the update. After the update, confirm **“Reboot”** by pressing Enter again "↵" to restart the updated module.

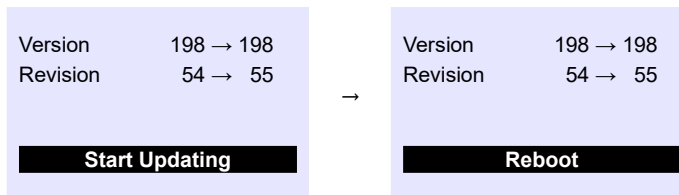

Fig. 1.13. Firmware update - rebooting

Important! After restarting the module, you should:

1. Wait at least 2 minutes.
2. Reset the frequency converter by turning off the power for at least 30 seconds.
3. Read the software version for each module in par. 09.10 – 09.15 and make sure that the displayed version is the same as uploaded version.

1.4.4. Faults messages

Table 1.4. Faults messages displayed

Displayed message	Possible cause	Counteraction
No USB drive	1. No USB flash drive plugged in USB port at mfc1000/11 communication module. 2. The USB flash drive has not been formatted in the supported FAT32 file system. 3. USB flash drive not supported.	1, 2. Connect a USB flash drive formatted in FAT32 file system. 3. Use a different USB flash drive.
File not found	1. Parameter or firmware file missing.	1. Upload the original file to the USB flash drive. 2. If the error persists, contact the manufacturer's service.
Hex corrupted	1. The file with the firmware has an incorrect checksum - the file has been modified or the USB flash drive is damaged.	1. Upload the original file to the USB flash drive. 2. Use a different USB flash drive. 3. If the error persists, contact the manufacturer's service.
Version not supported	1. Attempt to upload incompatible firmware.	1. Make sure the correct file is on the USB flash drive.
Comm error	1. Communication error with the AcR module. 2. Communication error with the VSD module.	1. Check the connection between the mfc1000/11 communication module (Control Board) and: <ul style="list-style-type: none"> • ACR Board - AcR module, • VSD Board - VSD module. 2. If the error persists, contact the manufacturer's service.

2. Configuration of the frequency converter

2.1. Setting nominal parameters of the motor

Before the first run of the frequency converter it is necessary to determine the nominal parameters of the motor. Appropriate data can be read from the rating plate. It is necessary to enter the following parameters:

par. 10.01 – nominal power of the motor P_n [kW]	par. 10.02 – nominal motor speed R_n [rpm]
par. 10.03 – nominal motor current I_n [A]	par. 10.04 – nominal motor voltage U_n [V]
par. 10.05 – nominal motor frequency f_n [Hz]	par. 10.06 – nominal $\cos\phi$ of the motor [-]

In the U/f scalar operation modes (par. **11.02 = 000 U/f linear** or par. **11.02 = 001 U/f square-law**) these data are sufficient to start the frequency converter.

2.1.1. Preparation for operation in a vector control mode

If you want to work in vector mode (with or without an encoder), then the drive must have additional information about the motor parameters, so-called engine equivalent circuit diagram parameters (Figure 2.1):

par. 10.11 – resistance of stator windings R_s [Ω]
par. 10.12 – resistance of rotor windings R_r [Ω]
par. 10.13 – main inductance L_m [mH]
par. 10.14 – inductance of a stator $L_s + L_m$ [mH]
par. 10.15 – inductance of a rotor $L_r + L_m$ [mH]
par. 10.16 – additional inductance - connecting cables, choke in series with the motor

In order to determine the values of these parameters, use the built-in function of the IDENTIFICATION RUN described in chapter 3.1. *Vector mode. Identification run*. It is also possible to enter them manually (or to adjust the values obtained from the identification run).

Without the correct determination of these parameters, the operation in the vector mode is not possible. Setting of incorrect values will result in the malfunction of the system. These parameters correspond to the motor in the star connection (U_s is the phase voltage).

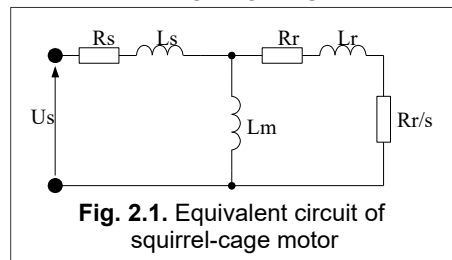

After performing the IDENTIFICATION RUN procedure or manually entering these parameters, the parameter **11.02** "OPERATING MODE" should be set to:

- **002 Vector without sensor** – sensorless mode – does not require an encoder, but it is less accurate,
- **003 Vector with sensor** – operation mode with a position sensor (encoder) - the encoder resolution is determined by the parameter **12.02**; this operation mode is especially recommended for operation at low speeds (below **2.0 Hz**).

2.2. Control

The basic possibilities of controlling the drive - referencing the output frequency (rotation speed) and the configuration of the START / STOP signal control with additional information about the configuration of output relays of a converter are described below.

2.2.1. Structure of control

The control system of the MFC810/MFC1000 converter uses the structure of four independent "control places" A1 / A2 and B1 / B2. This makes it possible to easily change the entire drive control structure by means of the parameters **20.01** and **20.02**, i.e. the sources of START and STOP signals and the source of the set operating frequency. Figure 2.2 shows a simplified system control structure.

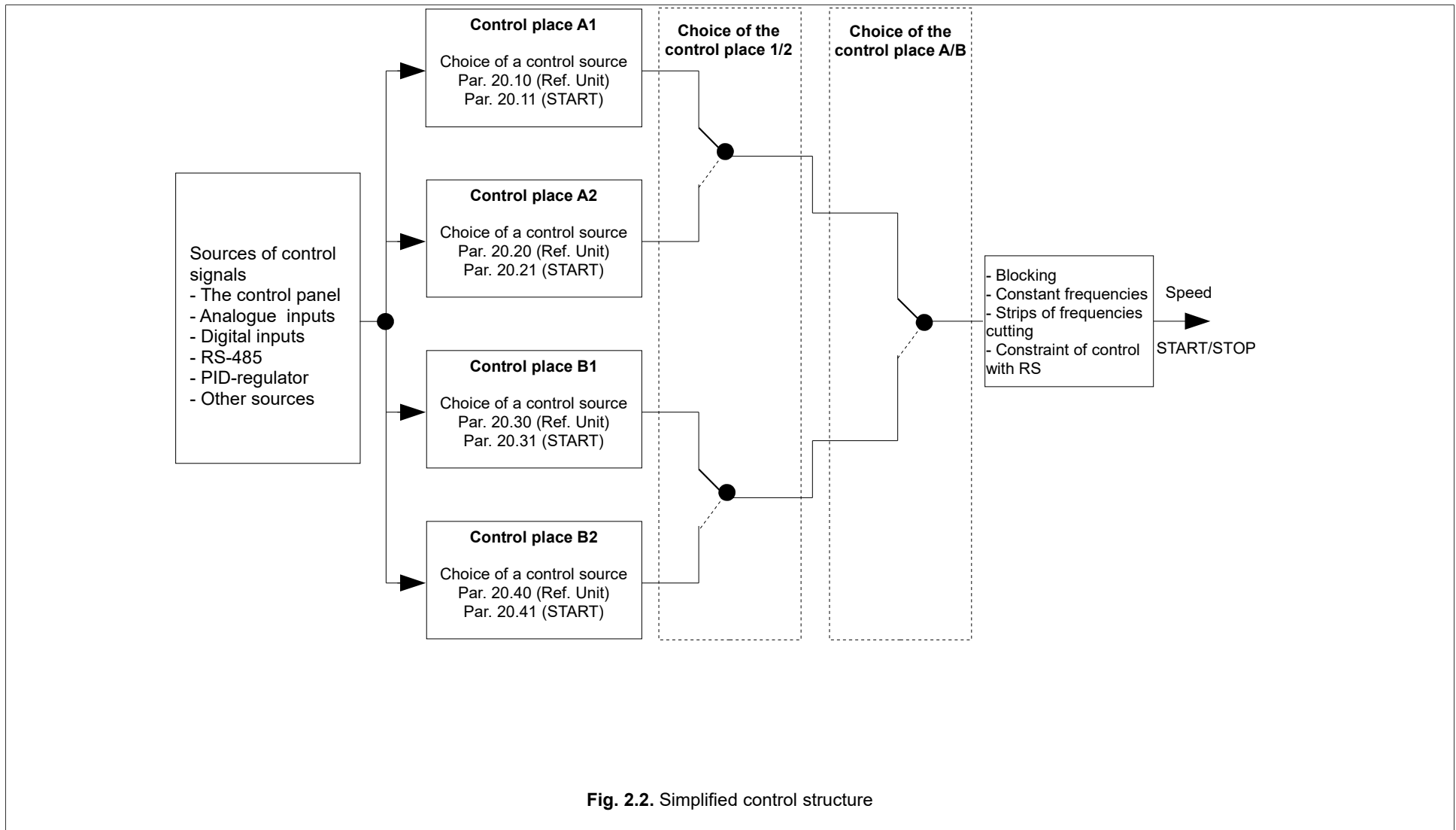



Fig. 2.2. Simplified control structure

2.2.2. Control from the control panel

In order to control the drive from the control panel it is necessary:

- to select **A1, A2, B1 or B2 "control place"** using the following parameters: **20.01** and **20.02**.
- The parameters: **20.10** (for A1), **20.20** (for A2), **20.30** (for B1), **20.40** (for B2) should be set to **300 Keyboard ref**
- The parameters: **20.11** (for A1), **20.21** (for A2), **20.31** (for B1), **20.41** (for B2) should be set to **000 Keyboard**
- Make sure that the constant speed selection is not active, i.e. the parameters: **23.01, 23.02, 23.03** and **23.04** should be set to **000 DISABLED**

With this configuration, the changes in the system frequency value (or rotation speed in vector mode) are made using the keys  . The motor is started and stopped also from the Panel with the LEFT / RIGHT and STOP keys.

2.2.3. Control via digital and analog inputs

In order to control the drive from the terminal block using digital and analog inputs, e.g. **START STOP through digital inputs and regulation of rotation speed using a potentiometer**, it is necessary to:

- Select **A1 or A2** and **B1 or B2** "control place" with the following parameters: **20.01** and **20.02**. It is recommended not to modify the existing A1 control place, which is assigned to the Control Panel by default.
- Define the signal source of the converter output frequency reference. Among many available options, the potentiometer connected to the **A1** analog input can be the signal source of the reference. For that purpose, **20.10** (for A1) or **20.20** (for A2) or **20.30** (for B1) or **20.40** (for B2) should be set to: **311 Ref An. 1**.
The source of the frequency converter reference can also be: the drive control panel, PID controller output, motorized potentiometer, communication interface (RS-485 or other), internal PLC, any of PCH characteristic points.
- The control logic allows you to configure 4 remote sources of references (Remote 1, Remote 2, Remote 3, Remote 4) and then select one of them. This example uses the Remote 1. For that purpose, the parameter **20.11** (for A1) or **20.21** (for A2) or **20.31** (for B1) or **20.41** (for B2) should be set to: **002 Remote 1**.
- Each remote reference source (Remote 1..4) is configurable via 4 values describing the given remote source. The parameters configuring Remote 1:
 - **Remote 1 mode** par. 20.50 – remote operation mode according to tab.2.1
 - **Remote 1 Inp.1** par. 20.51 – selection of digital input (DI) as input signal Input 1
 - **Remote 1 Inp.2** par. 20.52 – selection of digital input (DI) as input signal Input 2
 - **Remote 1 Inp.3** par. 20.53 – selection of digital input (DI) as input signal Input 3

Table 2.1. Possible configuration variants of remote start (START)

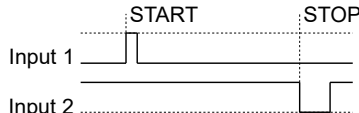
Remote 1.. 4	Function	Explanation
000 ST. L/R	Input 1 = Start/Stop Input 2 = Direction	Voltage feeding into digital input 1 results in the drive start, while voltage removal - in the drive stop. The condition of digital input DI2 defines determines the change of the motor rotation direction.
001 ST. R ST. L	Input 1 = Start right Input 2 = Start left	Voltage feeding into digital input 1 results in the start of the motor. Voltage feeding into digital input DI2 results in the motor start in opposite direction.
002 IM ST IM STOP	Input 1 = Pulse start Input 2 = Pulse stop	If a voltage pulse is applied to input 1 at high input 2, the motor will start. Removing the voltage from Input 2 will stop the motor. The direction of rotation is determined only by the reference sign. 
003 IM ST IM ST LR	Input 1 = Pulse start Input 2 = Pulse stop Input 3 = Direction	As above, the direction of operation of the system determines the state of input Input 3.
004 ONLY START	Input 1 = Start / Stop	Voltage feeding into digital input 1 results in the drive start, while voltage removal - in the drive stop. The direction of rotation is determined only by the referencing-unit.

Note: The minimum duration of the control pulse is 10 milliseconds.

2.2.4. Work with constant speeds

The system can work at any given moment with one of 16 constant speeds. **The choice of constant speed is made by means of digital inputs defined in group 23 by the parameters 23.01, 23.02, 23.03 and 23.04.** Constant speed values are defined by the parameters:

par. 23.06 – constant frequency 1 [Hz]	par. 23.14 – constant frequency 9 [Hz]
par. 23.07 – constant frequency 2 [Hz]	par. 23.15 – constant frequency 10 [Hz]
par. 23.08 – constant frequency 3 [Hz]	par. 23.16 – constant frequency 11 [Hz]
par. 23.09 – constant frequency 4 [Hz]	par. 23.17 – constant frequency 12 [Hz]
par. 23.10 – constant frequency 5 [Hz]	par. 23.18 – constant frequency 13 [Hz]
par. 23.11 – constant frequency 6 [Hz]	par. 23.19 – constant frequency 14 [Hz]
par. 23.12 – constant frequency 7 [Hz]	par. 23.20 – constant frequency 15 [Hz]
par. 23.13 – constant frequency 8 [Hz]	par. 23.21 – constant frequency 16 [Hz]

2.2.5. Motopotentiometer

The motopotentiometer is an "increase/decrease" device designed to control, for example, the motor rotation speed by means of two key arrows ("up", "down"). The MFC810/MFC1000 frequency converter has 4 built-in motorized potentiometers. The parameters responsible for the configuration of motopotentiometers can be found in the **"22 Motopotentiometers"** parameter group.

Table 2.2. List of the parameters responsible for the configuration of motopotentiometers

Group 22 — Motopotentiometers				
Parameter / Name	Function	Available options / measurement unit	Factory setting	Change during operation
22.01 Mtp1 adr up	Signal source "Increase" when the motopotentiometer 1 is a referencing-unit	000 Disable 001 DI1 .. 010 DI10 - increase referencing-unit if the voltage is supplied on the digital input DI1..DI10	000 Disable	Yes
22.02 Mtp1 adr down	Signal source "Decrease" when the motopotentiometer 1 is a referencing-unit	000 Disable 001 DI1 .. 010 DI10 - decrease referencing-unit if there is voltage on the digital input DI1..DI10	000 Disable	Yes
22.03 Motopot1 mode	Operation mode of the motopotentiometer 1	000 Stop reset – stopping the system by sending the STOP signal (via the control panel, RS communication or other possibilities) resets the motopotentiometer setting. 001 Parameter without change – the motopotentiometer setting value is stored in the memory. There is no possibility of changing this setting during the stoppage. 002 Traced referencing-unit – the value of current referencing-unit setting is traced by motopotentiometer. Applied for gentle transmission from current ref.-unit to motopotentiometer. 003 Parameter with change – the value of motopotentiometer setting is stored in the memory. There is a possibility of changing this setting during the stoppage. CAUTION: 000, 001, 002: modes used when the current referencing-unit (the parameters 20.10, 20.20, 20.30, 20.40) is set to Motopot 1 .. Motopot 4 003: mode independent of the current referencing-unit setting	002 Traced referencing-unit	Yes
22.04 Motopot1 time	Time of increase/decrease of motopotentiometer 1 ref.-unit	0.0.. 320.0 s	10.0 s	Yes
22.11 Mtp2 adr up	Signal source "Increase" when the motopotentiometer 2 is a referencing-unit	000 Disable 001 DI1.. 010 DI10 — increase referencing-unit if the voltage is supplied on the digital input DI1..DI10	000 Disable	Yes
22.12 Mtp2 adr down	Signal source "Decrease" when the motopotentiometer 2 is a referencing-unit	000 Disable 001 DI1.. 010 DI10 — decrease referencing-unit if the voltage is supplied on the digital input DI1..DI10	000 Disable	Yes

Group 22 — Motopotentiometers				
Parameter / Name	Function	Available options / measurement unit	Factory setting	Change during operation
22.13 Motopot2 mode	Operation mode of the motopotentiometer 2	See the parameter 22.03		
22.14 Motopot2 time	Time of increase/decrease of motopotentiometer 2 ref.-unit	0.0.. 320.0 s	10.0 s	Yes
22.21 Mtp3 adr up	Signal source "Increase" when the motopotentiometer 3 is a referencing-unit	000 Disable 001 DI1.. 010 DI10 — increase referencing-unit if if the voltage is supplied on the digital input DI1..DI10	000 Disable	Yes
22.22 Mtp3 adr down	Signal source "Decrease" when the motopotentiometer 3 is a referencing-unit	000 Disable 001 DI1.. 010 DI10 — decrease referencing-unit if if the voltage is supplied on the digital input DI1..DI10	000 Disable	Yes
22.23 Motopot3 mode	Operation mode of the motopotentiometer 3	See the parameter 22.03		
22.24 Motopot3 time	Time of increase/decrease of motopotentiometer 3 ref.-unit	0.0.. 320.0 s	10.0 s	Yes
22.31 Mtp4 adr up	Signal source "Increase" when the motopotentiometer 4 is a referencing-unit	000 Disable 001 DI1.. 010 DI10 — increase referencing-unit if if the voltage is supplied on the digital input DI1..DI10	000 Disable	Yes
22.32 Mtp4 adr down	Signal source "Decrease" when the motopotentiometer 4 is a referencing-unit	000 Disable 001 DI1.. 010 DI10 — decrease referencing-unit if there is voltage on the digital input DI1..DI10	000 Disable	Yes
22.33 Motopot4 mode	Operation mode of the motopotentiometer 4	See the parameter 22.03		
22.34 Motopot4 time	Time of increase/decrease of motopotentiometer 4 ref.-unit	0.0.. 320.0 s	10.0 s	Yes

An exemplary way of connecting the "Increase" and "Decrease" keys to the drive is shown in figure 2.3. In this example, the digital inputs DI3 and DI4 are used.

To set the output frequency of the drive using a motor-potentiometer, set the output frequency of the drive in the selected parameter responsible for the source of the reference signal **20. 10** (for A1) or **20. 20** (for A2) or **20. 30** (for B1) or **20. 40** (for B2):

- **305 Motopot 1** for motopotentiometer 1
- **306 Motopot 2** for motopotentiometer 2
- **307 Motopot 3** for motopotentiometer 3
- **308 Motopot 4** for motopotentiometer 4

Each motopotentiometer can work in one of four operation modes, see table 2.4.

Table 2.3. Operation mode of the motopotentiometer

The number of the motopotentiometer operation mode	Description
0	Stopping the drive causes resetting of motopotentiometer settings.
1	When the drive is stopped, the motopotentiometer setting value is stored in the memory. There is no possibility of changing this setting during the stoppage.
2	The value of current speed setting is traced by the motopotentiometer, which makes it possible to smoothly switch from the current reference-unit of to the motopotentiometer referencing-unit. The Mode 2 is dedicated to configuration when the motopotentiometer used for direct control of the referencing-unit (par.: 20.10 for A1 or 20.20 for A2 or 20.30 for B1 or 20.40 for B2) is set to any of four motopotentiometers: <i>Motopot 1, Motopot 2, Motopot 3, Motopot 4.</i>
3	When the drive is topped, the value of motopotentiometer setting is stored in the memory. There is a possibility of changing this setting during the stoppage.

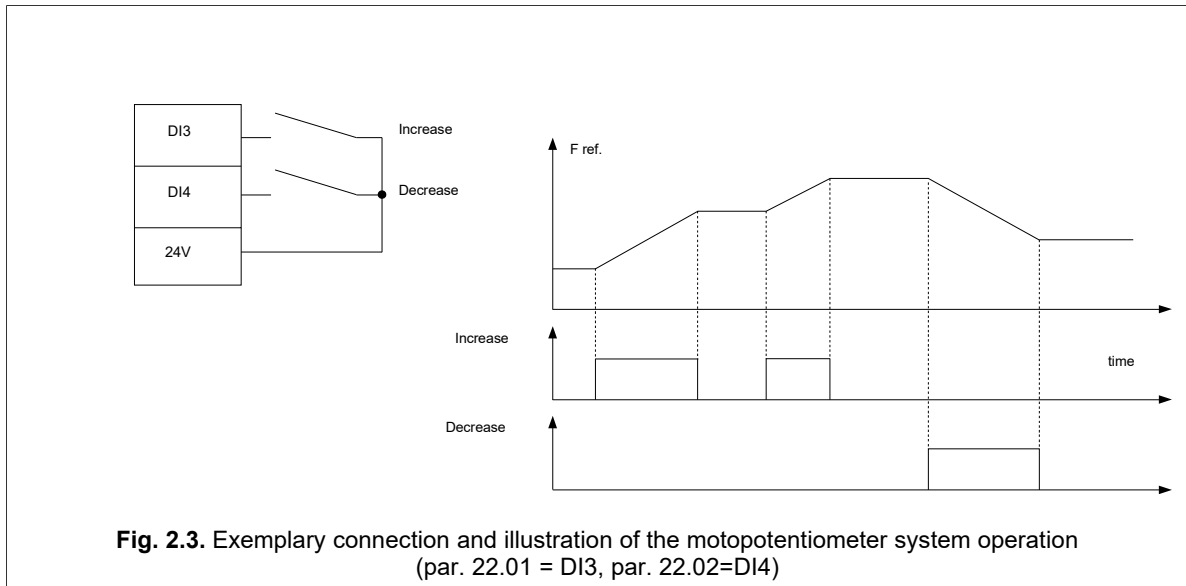

2.2.6. Other possibilities of the frequency converter control

The most important options include:

- change of control place A / B e.g. using a digital input – par. **20.01**,
- change of the control variant 1 / 2 using a digital input – par. **20.02**,
- mixed control – e.g. referencing frequency from the control panel and a START / STOP signal from digital inputs,
- referencing frequency from an output of the PID controller,
- advanced functions related to the use of a built-in PLC or a control system of group of pumps.

2.2.7. Configuration of digital and analog inputs and outputs

• Digital inputs

As a standard, the system has 10 digital inputs marked as DI1 ÷ DI10. This amount can be increased up to 40 by using optional expansion modules.

Submission of 24V voltage on any digital input sets it in a logic state 1. The current state of digital inputs can be read in the parameters of the "03 Input / output" group .

Digital inputs have no parameters which define their function. The digital input is "selected" to fulfil a specific function by parameters related to a given drive function: e.g. in order to select the change of the A / B control variant by means of digital input DI4, the parameter **20.01** should be set to "**003 Input 3**". This means that there is a possibility of simultaneously assigning more than one function to this digital input.

• Analog inputs

The system has 5 analog inputs. Inputs 1,2,3,4 can operate in both voltage 0 (2) ... 10V mode as well as in current mode 0 (4) ... 20mA. Input 0 works only in voltage mode.

The analog inputs can be connected directly to a potentiometer or a voltage (current) source. As in the case of digital inputs, analog inputs do not have any parameters describing their functions in the system, but they are "selected" to fulfil a specific function by configuration parameters from the "**24 Analog input**" group.

Table 2.4. Parameters configuring analog inputs

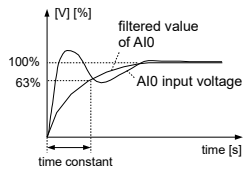
Parameter	Function	Description
24.01	Configuration of analog input	Voltage range: 000 0–10 V, 001 10–0 V, 002 -10 – 10 V
24.11 24.21 24.31 24.41		Voltage range: 000 0–10 V, 001 10–0 V, 002 2–10 V, 003 10–2 V Current range: 004 0–20 mA, 005 20–0 mA, 006 4–20 mA, 007 20–4 mA
24.x2 ^{*)}	Scale configuration	-500.0 .. 500.0 %
24.x3 ^{*)}	Configuration of the offset	-500.0 .. 500.0 %
24.x4 ^{*)}	Constant time of the low-pass filter	
from 03.21 to 03.50	The value of the input	Possibility to read the input value in electrical values and percentages.
32.01	Activation / deactivation of the failure signal	In operation modes 2. . . 10V, 10. . . 2V, 4. . . 20mA and 20. . . 4mA, it is possible to define the behaviour of the system when the voltage value drops below 2V or the current value drops below 4mA.
32.02	Response to the lack of signal at Analog Input	

*where "x" stands for the digital input number from 0 to 4.

• Relay outputs

As a standard, the system has 6 relay outputs K1-K6. With the help of extension modules, this amount can be increased. Parameters configuring relay outputs are in groups 27 and 28. For each of the relay outputs it is possible to define:

- performed function,
- switch-on delay time,
- the delay time of the shutdown,
- inversion of the signal.

Table 2.5. Configuration of the relay outputs on the example of the K1 output

Parameter	Description	Comments
27.40 Rel. 1 adr	Function performed	E.g. operation, breakdown, readiness, etc.
27.41 Rel. 1 time ON	Switch-on delay time	The possibility of setting the delay of switching the relay.
27.42 Rel. 1 time OFF	The delay time of the shutdown	The possibility of setting the delay of switching off the relay.
27.43 Rel. 1 inv	Inversion of the signal	Negating the signal logic .

• Analog outputs

As a standard, the system has two analog outputs. With the help of extension modules, this number can be increased to further 10 outputs. The outputs can work in the following modes:

- voltage: 0-10V, 10-0V, 2-10V, 20-2V
- current: 0-20mA, 20-0mA, 4-20mA, 20-4mA.

In addition, for each analog output you can individually configure scale, offset and filter. The configuration parameters can be found in group 25.

Caution: Analog outputs in voltage mode should be loaded by impedance in value not less than 10kΩ.

2.3. Configuration of the drive

2.3.1. Determining the dynamics and method of stopping the drive

Dynamics decides about the changing rate of the electric motor rotation speed – start, stopping and reverse speed. In MFC810/MFC1000 converter you can choose the dynamics from two accessible variants which are named DYNAMICS1 and DYNAMICS2. Using two acceleration/deceleration sets allows you to assign them different times and then switch between them using just one **13.35** parameter. The parameters related to the system dynamics and limitations (limits) are collected in group 13.

par 13.01 – Acceleration 1 – acceleration time from 0Hz to 50Hz (Dynamics 1)

par 13.02 – Deceleration 1 – deceleration time from 50Hz to 0Hz (Dynamics 1)

par 13.10 – Acceleration 2 – acceleration time from 0Hz to 50Hz (Dynamics 2)

par 13.11 – Deceleration 2 – deceleration time from 50Hz to 0Hz (Dynamics 2)

par 13.20 – Stopping time - deceleration time from 50 Hz to 0 Hz after the STOP command

- when the parameter value is greater than zero, then it defines the deceleration time from 50 Hz to 0 Hz after the STOP command (e.g. from the control panel, digital inputs, internal PLC, through RS)
- when the parameter value is 0.0, then this parameter is inactive and the deceleration time depends on the time set in the active dynamics (**par. 13.02** or **par. 13.11**).

par 13.30 – S Curve – allows to realize the smooth beginning and end of acceleration and deceleration

par 13.35 – Choice of DYNAMICS– allows to set up dynamics variant 1 or 2. You can also decide, that the choice of dynamics will be carried out through one of the digital inputs.

Caution:

1. *Setting up too low time of acceleration can result in occurrence of “high current” failures during the start-up, especially at significant loading of the motor.*
2. *The times given in par. 13.01, 13.02, 13.10, 13.11 refer to the acceleration of the system after the START command and reverse (delay + acceleration) after the REVERSE command. Time given in par. 13.20 applies to the system stop time after the STOP command. When par. 13.20 is set to 0.0, then the delay time (par 1.31 or 1.33) is also a deceleration time after the STOP command.*

It is possible to specify the minimal stop time as well as the referencing-unit delay in seconds :

par 11.68 – min t. Stop – minimal time needed to restart the electric motor after stopping it,

par 21.16 – referencing-unit delay– time needed for referencing-unit to run.

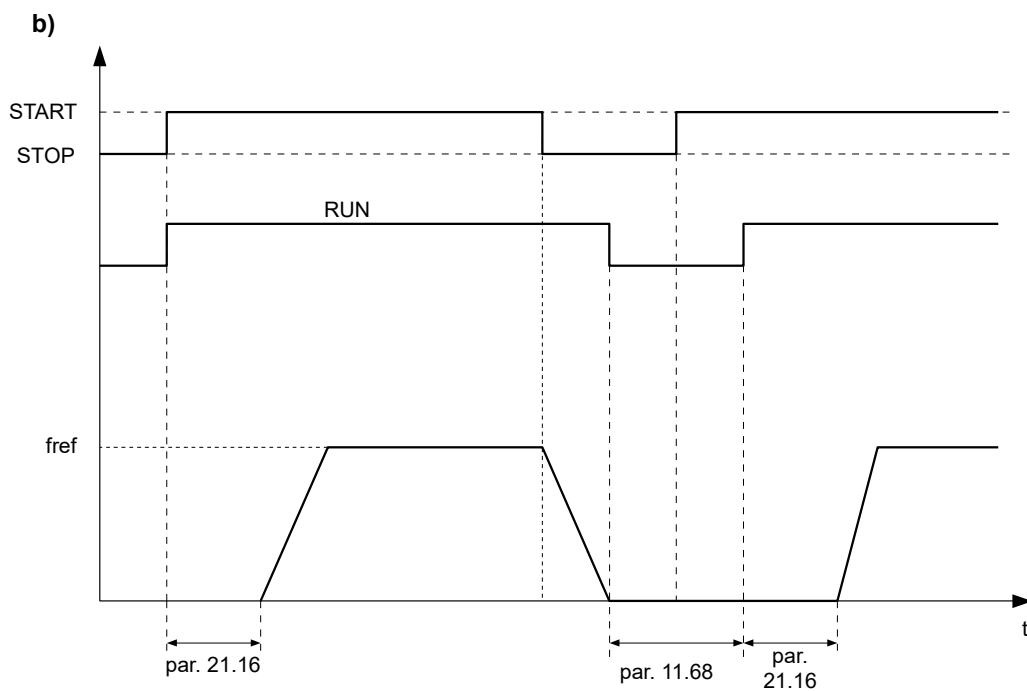
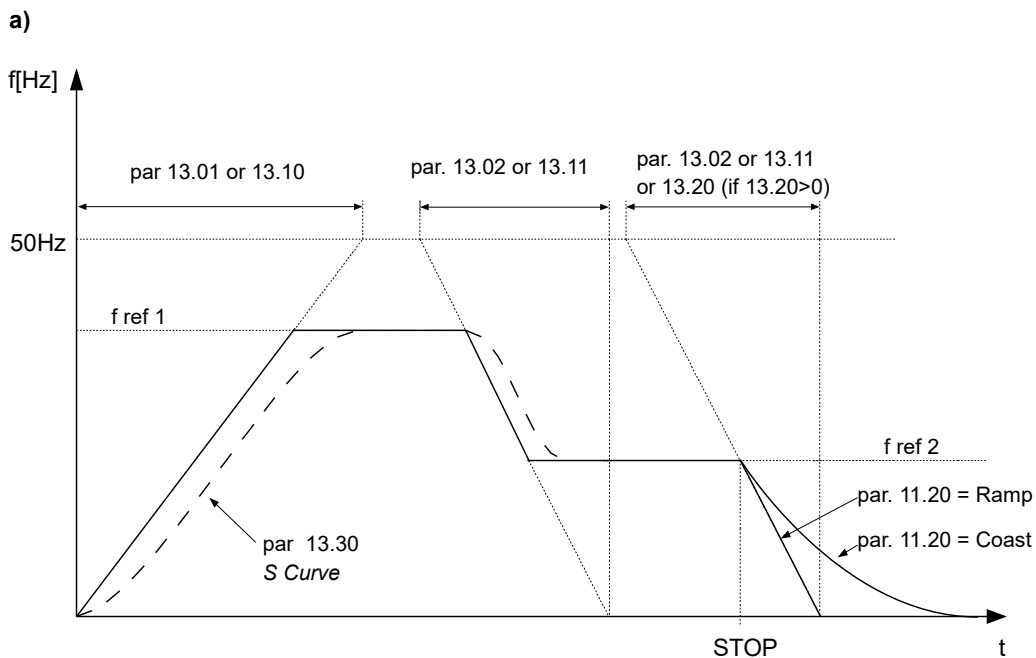

Figure 2.4 a) – Illustration of parameters of influence on dynamics and halting of the drive
Figure 2.4 b) – Illustration of influence of minimal stopping time and ref.-unit delay parameters

2.3.2. Setting the U/f characteristic

In the U/f scalar modes, it is possible to influence the type of the characteristic – figure. 2.5.
In vector modes (Vector 1 and Vector 2), the parameters of U/f characteristic formation are irrelevant.

The basic parameter affecting the shape of the system's characteristics is **par 11.2** :

- **000 U/f linear:** It is applicable where there is a constant load torque which does not depend on speed.
- **001 U/f square-law:** It is applicable if the load torque grows under the square-law speed (e.g. the electric drive of the fan). Use of U/f square-law characteristic causes reduction of noise and motor losses.

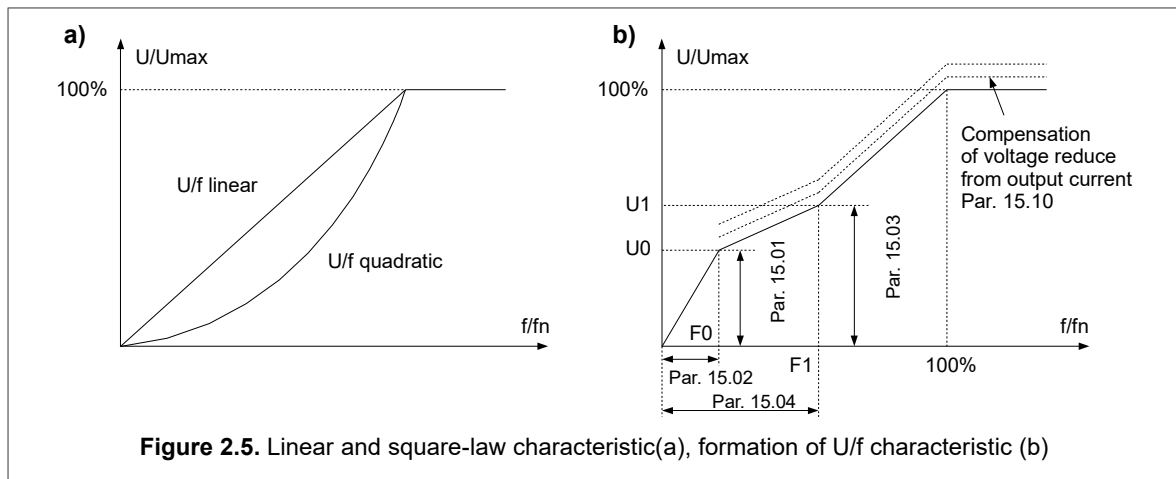

Figure 2.5. Linear and square-law characteristic(a), formation of U/f characteristic (b)

2.3.3. Elimination of frequencies

With the purpose of elimination of undesirable output frequencies which can result in the resonant phenomena of the drive, it is possible to determine 3 ranges called "ranges of elimination". Their options can be set up by the parameters:

- par 14.01 – bottom frequency of elimination range 1 [Hz]
- par 14.21 – top frequency of elimination range 1 [Hz]
- par 14.03 – bottom frequency of elimination range 2 [Hz]
- par 14.04 – top frequency of elimination range 2 [Hz]
- par 14.05 – bottom frequency of elimination range 3 [Hz]
- par 14.06 – top frequency of elimination range 3 [Hz]

Referencing-unit of the electric drive will "bypass" frequencies which are chosen by the above-mentioned parameters.

Note: the frequency elimination function applies to the frequency Fref. and does not affect acceleration or deceleration operations.

2.3.4. Mechanical brake

!!! CAUTION !!! In case when the full torque generation is required at zero speed of the drive, it is recommended to use vector mode of control – par. 11.02 „003 Vector with sensor” and to apply encoder.

MFC810/MFC1000 enables cooperation with the mechanical brake of the drive system. The example of the brake connection is presented in figure 2.6.

The brake is controlled by means of a properly configured relay input, marked as Kx in fig. 2.6, using the appropriate parameter from group 27 (par. 27.40 for relay K1, par. 27.44 for relay K2, etc.) set to "527 Brake".

Table 2.6 presents the configuration parameters. The principle of mechanical brake control is shown in fig. 2.6.

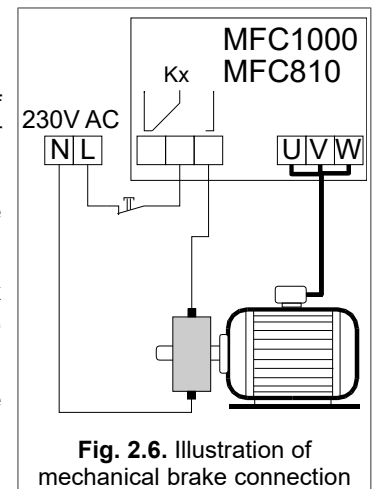
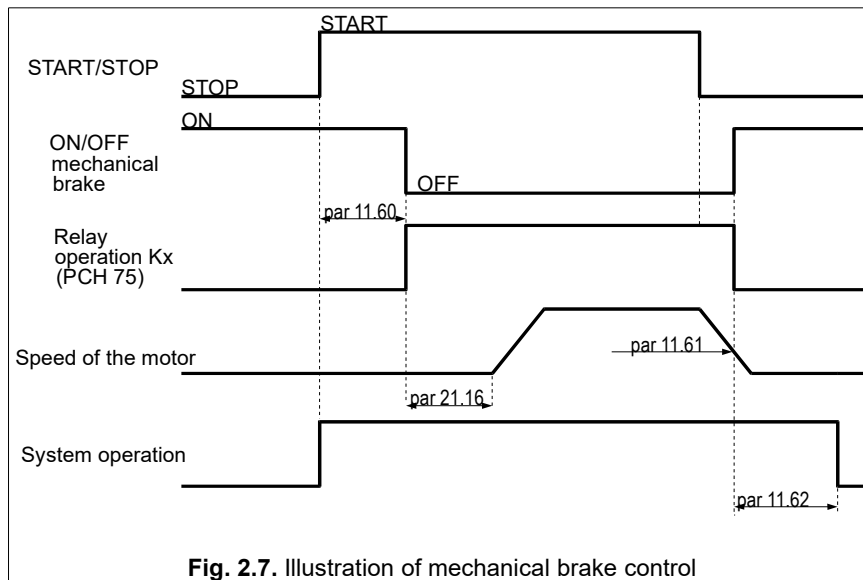

Fig. 2.6. Illustration of mechanical brake connection

Table 2.6. Configuration parameters of mechanical brake control

Parameter №	Name	Description
21.16	Ref. delay	Referencing-unit start-up delay [s].
11.60	Br rel. delay	Brake release delay [s] – time needed to magnetize the motor (not magnetized motor is unable to create torque).
11.61	Br. close n	Below this speed a command to close the mechanical brake is sent. [rpm]
11.62	Br. close t	Time of work after closing command is sent [s] – time needed for complete locking of mechanical brake.
11.63	Br. curr. lvl.	Minimal motor current for releasing brake [%] - % of motor's current



2.3.5. Flying start

The flying start enables the motor to start properly when the initial speed of the shaft is different from zero. Five modes are available, par. 11.30:

- 0 – function is switched off
- 1 – search in one direction, search frequency from Fref or Fmax
- 2 – search in two directions, search frequency from Fref or Fmax
- 3 – search in one direction, search frequency from Fmax
- 4 – search in two directions, search frequency from Fmax

The one-direction search should be used for drive systems in which, in case of switching off the voltage supplying the motor, the load **will not change** the direction of the system rotation.

The search in two directions should be used for drive systems in which, in case of switching off voltage supplying the motor, the load **can change** the direction of the system rotation.

For modes 1 and 2, the frequency search can start with the set frequency Fref. or the maximal frequency Fmax. It depends on whether the restart takes place or not:

- after pressing the key STOP (search from Fref),
- after restarting the frequency converter (search from Fmax).

For one-direction search, it is recommended to set **par. 11.30** to 1. In case of the search in two directions, it is necessary to set **par. 11.30** to 2.

2.4. Protection and blocking

2.4.1. Current, frequency, torque and power limitations

- **Current limitation:** In order to prevent overloading of the system, set the maximal permissible output current of the drive – the parameters **13.41** and **13.42** are factory-set to 150 % of the nominal current of the drive. The system will not allow the current to rise above this limit.
- **Output frequency limitation:** In order to exclude the possibility of setting frequency which considerably exceeds the nominal frequency of the motor, the parameter **13.40** allows to set the upper limit of the output frequency of the drive.

Caution: the parameter 13.40 specifies the output frequency limitation, but it does not change the set frequency assigned to 100% of the selected referencing-unit. For that reason, just changing the parameter 13.40 to a higher value will not cause the engine to run at a higher speed. To do this, change the parameter 21.20 and set the parameter 13.40 to a value higher than par. 21.20, e.g. by 5 Hz.

- **Torque limitation:** In order to exclude the motor and drive system impacts, the permissible torque on the motor shaft is set up by means of the parameters **13.43** and **13.44**. As standard, this is 150 % of the rating value of the torque.
- **Power limitation:**
 - **par. 13.50:** limitation of power consumed by the motor; the value given in relation to the nominal power of the converter,
 - **par. 13.51:** power limitation given by the motor, the value given in relation to the nominal power of the converter.

2.4.2. Blocking a direction of the motor rotation

There is a possibility of partial blocking of the drive for operation only in one direction. In this case, regardless of the control signals, the system will only rotate the motor in one direction. The parameter **11.25** allows to define this setting:

"Reverse" - operation in two directions (the default setting)

"Left" - operation in one direction

"Right" - operation in one direction

2.4.3. Blocking the drive operation

Activation of one of the following arbitrary blocking stops the motor and prevents it from running until the time of taking down the blocking signal (blocking cause).

- **External permission and blocking of operation:** two parameters allow to define digital input, which will serve as an external signal source for permission and blocking of operation:
 - **par. 26.02** – Blocking of operation – value "000 Disabled" (default) deactivates blocking of external operations,
 - **par. 26.01** - Permission of operation – value "531 Permission" (default) allows operation regardless of the status of digital inputs.
- **Blocking from thermorelay or thermistor in the motor:** the parameter **30.01** permits blocking to be activated from thermorelay protection. The choice of the temperature signal source is made using the parameter **30.02**.
- **External emergency stop:** instant stop of the drive in "coast" mode. See par. **26.03**. By default, the function is disabled "000 Disabled",
- **Blocking from "F STOP":** There is a built-in blockade in referencing-unit structure, which is activated by par. **21.11**. If it is set to "000 Limit", then par. **21.10** sets the minimum frequency below which the set frequency will not decrease (by default 0.5 Hz). If par **21.11** is set to "YES", then the par. **21.10** specifies the maximum frequency. If set frequency value falls below the limit value specified in the parameter **21.10**, the system blockade (STOP) is activated. The frequency increase above the specified the par. **21.10** will restart the system. The mode of switching on / off will be coordinated due to the characteristic such as "loop of hysteresis".

2.4.4. Thermal protections of the motor

Protection limit I^2t

The built-in thermal model of the motor enables to calculate the motor temperature in the theoretical way. The model is developed on the basis of the following assumptions:

- the temperature of windings changes according to the exponential law,
- the electric motor achieves the maximal temperature for continuous work at a nominal current,
- the temperature rise depends on the ratio $(I/I_n)^2$,
- the cooling time constant for the stopped motor is four times higher than the heating time constant during operation.

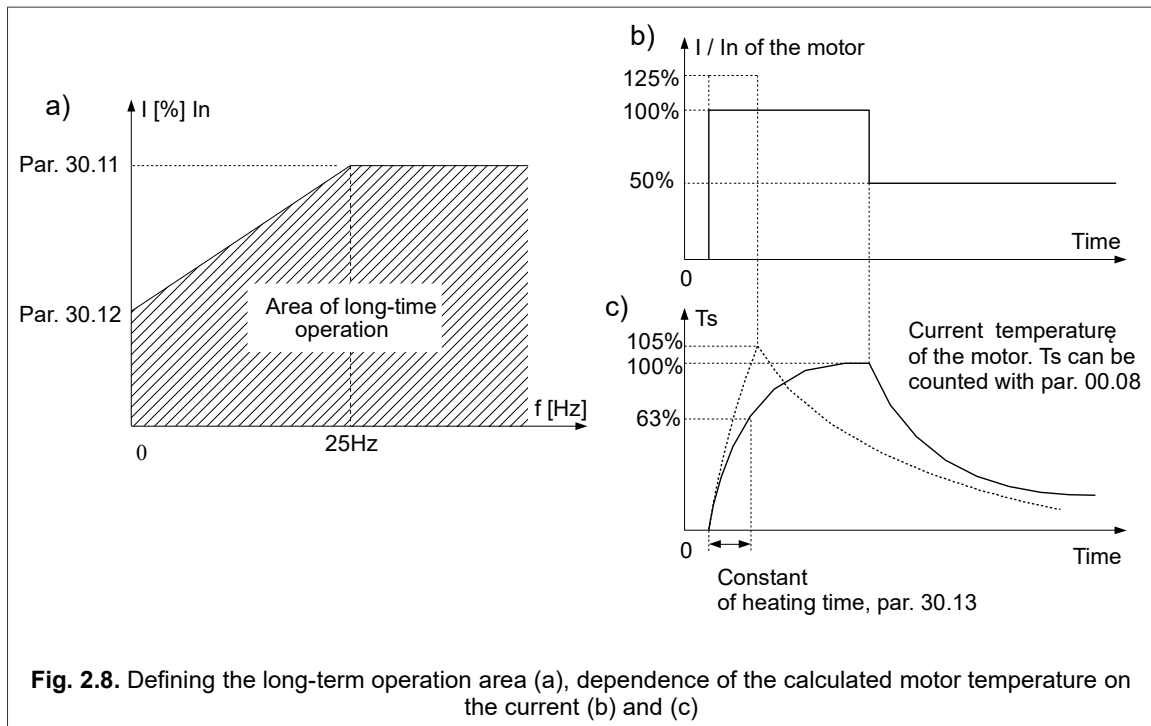

The relative **long-term current** of the motor for frequency higher 25 Hz is determined by the **parameter 30.11**. For frequency below 25 Hz, the long-term current is lower (lower efficiency of the cooling fan is located on the motor shaft) and determined by the parameter 30.12. These parameters are determined in relation to the nominal motor current for 100. 0% = I_n . In this way, the **long-term work area** is determined (figure 2.8a).

If the motor is cooled without any additional ventilation (only with the internal fan), par. **30.12** should be set to 35% of the

nominal motor current. If additional motor ventilation is applied, then the value of par. 30.12 can be increased up to 75%. If the motor current is outside of the defined area of long-term operation, the calculated temperature will increase above 100 %. When the calculated temperature reaches 105%, the system will be switched off and a fault message will appear. Such situation is represented in fig. 2.8c or an increase in temperature marked by a dotted line.

The rate of increase of the calculated temperature is determined by the parameter **30.13** — time constant for the motor heating. This is the time after which the motor temperature reaches 63% of the final temperature increase value. In practice it is possible to accept option:

par 30.13 = 120 * t_6 [min], where t_6 [s] is provided by a motor manufacturer.

3. The first start

Before the first start of the converter MFC810/MFC1000 it is necessary to check the section 2. *Configuration of the frequency converter*". The MFC810/MFC1000 control structure diagram (see chapter 2.2.1. *Structure of control*") and the table of MFC810/MFC1000 parameters are also important.

The most important settings:

- set the nominal parameters of the motor in group 10 – chapter: 2.1. *Setting nominal parameters of the motor*,
- configure the "control place" in group 20 – chapter: 2.2. *Control*.

3.1. Vector mode. Identification run

In order for the converter to work in the vector control mode, in addition to turning on the **Vector sensor** or **Vector sensor less** mode using parameter **11.02**, it is necessary to set the parameters of the equivalent motor diagram.

If we do not know these parameters, then we can use the **identification run** procedure built into the converter. After starting it, the converter will carry out 2 or 3 motor tests, during which an attempt will be made to determine the parameters of the equivalent circuit of motor.

Note: The identification run must be performed with the **11.02** on 000 "U/f lin." parameter setting.

3.1.1. Stages of identification run

Identification of parameters is divided into three stages:

- Stage 1: DC testing. The motor is stopped, the device defines active resistance of stator R_s ,
- Stage 2: AC testing. The motor is stopped, the device defines active resistance of rotor R_r , inductance of stator L_s and rotor L_r ,
- Stage 3: Running test f_n or $f_n / 2$.

3.1.2. Switching on identification run

!!! CAUTION !!!

1. Before starting the identification run, enter the rated parameters of the motor described in the chapter 2.1. *Setting nominal parameters of the motor* (nominal power, current, voltage, frequency and speed) – entering erroneous parameters can result in damage of the motor and the frequency converter.

2. During the identification run, the blocking of the motor rotation direction is not active.

3. Whenever possible, the motor should be disconnected from the load due to stage 3, during which the motor is accelerated to the speed corresponding to the frequency f_n or $f_n/2$. When it is impossible to disconnect the load, select "001 No run" in the parameter 10.20 "ID RUN".

To start the identification run procedure, set the parameter **10.20** "ID RUN" to one of the following values:

- **003 Run f_n** – all 3 stages of identification are carried out, stage 3 at 50 Hz.
- **002 Run $f_n/2$** - all 3 stages of identification are carried out, stage 3 at 25 Hz.
- **001 No run**– 3rd stage of parameters identification isn't carried out (in case when there is no possibility to perform tests with loading and it cannot be disconnected).

After setting the parameter **10.20** to one of the above-mentioned options, the display of the control panel will look as it is shown in fig. 5.1a. After pressing one of the START keys (left or right), the identification run procedure starts (fig. 5.1b, 5.1c and 5.1d). Depending on the motor parameters, stages 1 and 2 can last from a few to several dozen seconds. Stage 3 lasts about 20 seconds. After completing all the tests, the calculated parameters will be saved in the EEPROM of the converter (fig. 5.1e). Then the STOP key should be pressed to restart the converter and return to normal operation. You can also stop the test procedure at any time using the **STOP** key. The vector mode is obtained by changing par. **11.02**.

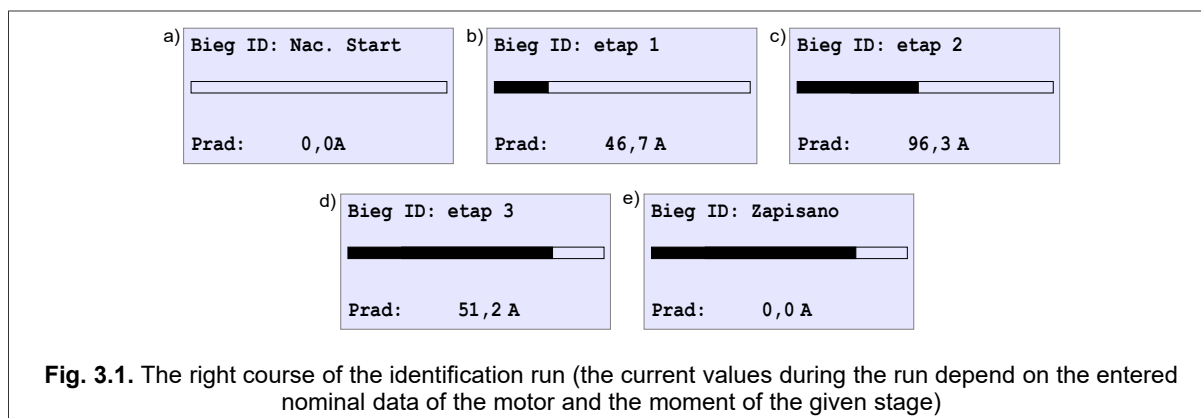

Fig. 3.1. The right course of the identification run (the current values during the run depend on the entered nominal data of the motor and the moment of the given stage)

NOTE 1. In case of stopping the identification run with the **STOP** key before its completion, the new motor parameters will not be stored.

NOTE 2. In case of the option (**001 No run**), the parameter Lm is calculated on the basis of other nominal parameters of the motor. Because of that, the Lm parameter can be erroneous.

NOTE 3. The Rr parameter is calculated on the basis of the nominal parameters of the motor. The nominal motor speed exerts the most influence on the Rr parameter. If it is found that the motor speed increases / decreases after its loading, the parameter **10.02** must be accordingly increased / reduced (which will reduce / increase Rr accordingly).

NOTE 4. In case of full identification procedure (three stages), which is carried out when the encoder is connected, no changes should be made to the parameter **12.03** (Enc. Reverser), because the direction of the encoder pulses counting is identified and correction of the parameter **12.03** is automatically carried out.

The error during parameter identification of the motor (fig. 3.2) can occur if:

- the motor is not connected to the frequency converter,
- the motor is damaged,
- the current during identification has exceeded 170 % of the motor nominal current,
- there is no possibility to define the parameters for this motor.

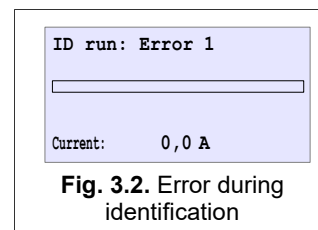

Fig. 3.2. Error during identification

After setting the motor and control parameters, the drive is ready to operate.

3.2. Storing and reading of settings for 4 different motors

Four sets of parameters related to a specific motor can be stored in EEPROM as well as read from this memory. This makes it possible to use one drive for operation with four motors, without the need to manually change the settings of the selected parameters. The parameter set includes the parameters from group 10.

Storing.

In order to make a record, select a memory buffer (from 1 to 4) in par. **10.18**, under which the above parameters will be saved, and confirm the entry. Selecting the ESC key will cancel the storing.

Reading.

To read the previously stored motor parameters, select the memory buffer (from 1 to 4) in par. **10.19**, under which the parameters we are interested in have been saved and confirm the reading. Selecting the ESC key will cancel the reading.

Caution. The storing/reading operation can be made only when the motor is stopped.

4. Failures and warnings

4.1. Failure messages and warnings on the control panel

The **failure status** is signalled by the red light-emitting diode (LED) and the display of the messages. Thus, the frequency converter passes to the **STOP** mode. To make the next **START**, it is necessary to remove the cause and erase the message of the failure. In case of some failures, the automatic restart (deleting of the message) is possible after the cause of the failure has disappeared.

The **warning state** is signalled by the appropriate message on the display without stopping the frequency converter, and also by the blinking red light-emitting diode (LED). The warning is automatically erased after the motor has stopped.

In both cases the operation of the panel is uninterrupted, i.e. you can easily view and change all parameters of the drive without any obstructions.

4.2. Deleting failure message. Automatic restarts

4.2.1. Manual deleting



Push for at least 2 seconds

4.2.2. Deleting through the digital input of the converter

The parameter **26.11** allows to select the digital input that will be used to delete the failure message.

4.2.3. Remote deleting through RS link

If the parameter 40.07 allows to operate with RS control mode, the sequence of 2 next records in the register 2000 (MODBUS) deletes the failure message. The detailed description of separate bits and methods of failures deleting can be found in the description of the register 2000 - chapter 8.

4.2.4. Readiness to restart if the cause of failure has not disappeared

If one of the methods described in sections 6.2.1... 6.2.3 has deleted the failure message and its cause has not disappeared, then the system remains in the "ready to restart" state. When the cause of the failure disappears, the system will restart automatically.

4.3. Failures and warnings codes

A list of failures and warnings codes can be found in chapter 10 "Failures and warnings codes" on page 43.

4.4. Failure log

The parameters of the Group 90 contain the Failures Log that allows to display the history of the last 32 failures.

Each entry in the failure register is contained in two parameters, the first of which informs about the failure code and the second — time of its occurrence. The parameters **90.01** and **90.02** refer to the latest failure record and the parameters **90.53** and **90.64** — to the oldest.

In one hour of the converter operation, the same failure can occur many times. In this case, in order to prevent overflow of the failure log, only the quantity of failures in a given operating hour is increased. Thanks to this, the real quantity of possible failures which the failure log can remember increases.

Additionally, during the time of failure it is possible to read:

- f_{OUT} – actual output frequency,
- U_{DC} – DC intermediate circuit voltage,
- I_{OUT} – actual electric motor RMS current (average value of the three phases),
- T_{RAD} – actual heatsink temperature,
- T_{ORQ} – actual torque (unit: percent of the rated value),
- $T_{ORQ REF}$ – referenced torque (unit: percentage of the nominal value),
- RPM – actual speed of the electric motor,
- RPM_{REF} – referenced speed,
- Status word 1 – service data,
- Status word 2 – service data.

To do this, press function key while viewing a failure code (par. 90.01, 90.03, ...).

In addition, through the Modbus protocol, it is possible to read the last 256 failures. For each of the failures, there is a 15-address data space. Failure no. 1 is the latest failure and corresponds to the failure stored in parameters 90.01 and 90.02.

Table 4.1. Failure history register - Modbus base addresses

Failure number	Base address
1	4000
2	4015
3	4030
...	
255	7810
256	7825

Table 4.2. Failure history register – contents of the Modbus frame

Base address + ...	Content	Unit
0	Failure code	-
1	Time of failure - higher register bits	Unix Time
2	Time of failure - lower register bits	
3	Status Word 1	-
4	Status Word 2	-
5	f_{OUT} – output frequency	0.1 Hz
6	RPM – real speed	rpm
7	RPM_{REF} – speed reference	rpm
8	I_{OUT} – RMS value of motor current (average of 3 phases)	0.1 A
9	Torq – actual torque (unit: percent of rated value)	0.1 %
10	$Torq_{REF}$ – torque reference (unit: percent of nominal)	0.1 %
11	UDC – DC-link voltage	1 V
12	Temperature of power module (IGBT or SiC)	1 °C
13	User / access level	-
14	Quantity of failures	-

Example

The temperature of the heatsink during fault number 1 is stored in address 4012.

5. PID controllers

The system has four built-in PID controllers: PID1, PID2, PID3, PID4. These controllers can be used for stabilization of any parameters at fixed level.

5.1. Limitation of saturation and SLEEP function

The maintenance of a positive or negative error for some time may lead to saturation of the output value of the PID controller. To prevent this phenomenon, it is necessary to limit output value of the controller:

- the lowest output value - **par. 29.08** (PID1), **29.28** (PID2), **29.48** (PID3), **29.68** (PID4) (by default 0.0 %),
- the highest output value - **par. 29.07** (PID1), **29.27** (PID2), **29.47** (PID3), **29.67** (PID4)(by default 100.0 %).

The SLEEP function of the PID controller enables automatic stopping of the motor operation when the output value of the PID controller, which at the same time is a frequency referencing-unit of the system operation, is kept at the minimum determined by par. **29.12** (PID1), par. **29.32** (PID2), par. **29.52** (PID3), par. **29.72** (PID4) during the time specified by par. **29.11** (PID1), **29.31** (PID2), **29.51** (PID3), **29.71** (PID4). The system will then be blocked. Unlocking will occur automatically when at least one of the following conditions is fulfilled:

- the controller output will reach a value higher than (PID x min out + PID x Sleep tresh) - for PID1 these will be the parameters **29.08 + 29.12**,
- the error will be higher than $PID \times Sleep \ tresh$ - **par. 29.12** for PID1.

Functioning of limitation and SLEEP blocking is illustrated in fig. 8.1.

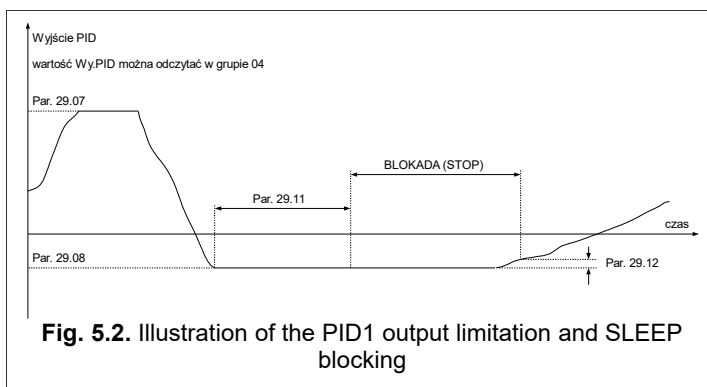
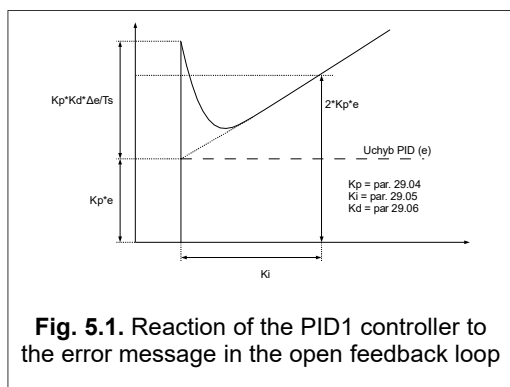

6. Advanced programming

In order to use completely the frequency converter capabilities and master the art of programming, familiarize with the following terms:

Characteristic point (abbreviation: PCH) – any of the available 999 values being a reflection of the current system operation status, e.g. there are characteristic points responsible for the status of digital inputs and outputs, referencing-units' values, points that are the outputs of the OUT blocks of the PLC drive, etc.

Pointer – a parameter determining which of the available 999 different characteristic points (PCH) will be taken as an input value in certain place of process. Many standard parameters determining the work of MFC810/MFC1000 are in fact pointers, which allows, for example, to link the work of the system with the built-in PLC.

6.1. Characteristic Points (PCH)

Each of the 999 Character Points is a 16-bit number and can take a numeric value ranging from 0 to 65536 for unsigned numbers or from -32768 to 32767 for signed numbers. If a given PCH is treated as a digital value (logic 0 or 1), then the value of "logic 0" corresponds to the value PCH = 0 and the value "logic 1" corresponds to any PCH value $\neq 0$. PCHs are numbered from 0 to 999. Some of them are named so that their function could be clearly displayed on the control panel. Part of PCH remains unused, intended for future use. Table 6.1 shows the general classification of PCH.

Table 6.1. General classification of PCH

PCH number	Value	PCH number	Value
0...199	Analog / digital inputs / outputs	600...699	Failures
200...249	Electrical quantities (currents, voltages, frequency) and mechanical (rotations, torque, power) - set and measured	700...799	Communication
250...280	Temperature of converter's part, active rectifier, external sensors (PT100)		
300...499	Referencing-units	800...899	Advanced systems: pumps, reel calculator
500...599	Control		

6.2. PCH and the pointers – how it works

Pointers and PCH cooperates with each other. The value of the pointer (within the range of 0 ... 999) determines which PCH will be selected - the value of this PCH is the output value (fig. 6.1).

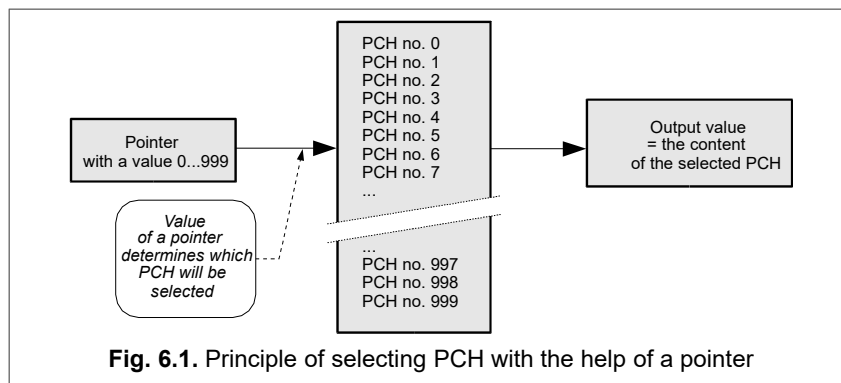

6.3. Modification of standard control

Part of the parameters in the MFC810/MFC1000 are defined as pointers. Due to this, it is possible to change the standard way of controlling the converter by connecting other PCHs by means of these parameters, e.g. outputs of PLC controller blocks implementing any control algorithm.

For safety reasons, the parameters, which are pointers and concern the operation of the converter, have restricted range of selecting PCH. They are reduced to the several standard values. This guarantees that an inexperienced user will not change this parameter to an unspecified value. However, if the designed application demands different from standard setting of the pointer (and this is the case if you want to use the built-in PLC system or the pumps group controller to control the drive), the parameter **40.06** "Full PCH" must be set to **001** "Yes".

Operation sequence at change of standard control:

1. Unlock the option to change the parameters as described in chapter 1.
2. Set the parameter **40.06** to **001** "Yes".
3. Change the drive parameter you want to use as a pointer.
4. If it is necessary block possibility of parameters changing.

7. „Backspin control” - Backspin Control for high-pressure pumping stations (optional)

Optional Backspin control (BCS) allows you to control the backflow of oil or other liquid during power failure and to stop the pump in a controlled manner. Power failure means the absence of one phase in the supply voltage or the complete absence of the supply voltage.

a. Operation of the converter at the failure of one phase in the supply voltage

In order to activate the function enabling operation of the converter after one phase loss in the supply voltage, parameter **11.43** must be set to **001 Yes** - this will activate the phase loss regulator. Then, in the event of a single phase loss, the converter will reduce the output frequency to a level that ensures voltage ripple of a safe value for the capacitors in the DC-link intermediate circuit.

b. Backspin Control by a total power loss

The Backspin control is activated by setting parameter **17.01** to **001 Yes**. This will activate the algorithm that enables the recovery of potential energy from the liquid column (e.g. oil) in the event of a power loss. As a result, the rate of descent of the liquid column will be slowed down. This slowdown will allow for a faster return to normal operation after a short-term power failure and may help prevent potential damage.

Algorithm of converter operation at total supply voltage loss

The supply voltage loss causes the ACR active rectifier module to stop operation, change direction of motor speed, transition of the inverter to the generator operating state and to the voltage regulation state in the intermediate circuit. The speed in the backflow generator state is limited by setting **17.03 BSC freq min** (minimum Backspin operating frequency) and **17.04 BSC freq max** (maximum Backspin control frequency).

Operation with backspin control must be in sensed vector mode (par. **11.02 = 003 Vector sensor**) or sensorless vector mode (par. **11.02 = 002 Vector s. less**).

In the sensorless vector mode of operation (par. **11.02 = 002 Vector s. less**), due to the limited accuracy of rotational speed estimation at low speeds, the rotational speed cannot be lower than 1 Hz.

Operation in the "Backspin control" mode may cause an increase in the voltage in the intermediate circuit to the level requiring the activation of external resistors. Therefore, it is recommended to connect an external braking resistor to the **DC+ BR** terminals.

As soon as the converter supply voltage returns, the AcR active rectifier module starts working again and informs the converter control block to start the procedure of returning to the speed at which the converter was running before the power loss. The speed change is linear with the ramp set by parameter **17.02 BSC acc**.

c. DC braking

If the converter is operating in a high-pressure pumping station system, forcing (pumping) liquid, there is a possibility of stopping, as a result of which the liquid will not be lifted up, but at the same time it will not cause it to fall. This is done by activating DC braking in parameter **11.52 Ham. enable**.

The behavior of the converter when a STOP command is issued is defined by parameters **11.51 DC breaking time** and **11.52 DC breaking enable**. Parameter **11.51** defines the time during which DC braking is to operate. Value **0** means that there is no time limit and braking will last until the START command is called.

DC braking activation can also be activated via a digital input. For example, if parameter **11.52 = 002 Input 2**, a low state of digital input **DI2** means that DC braking is disabled, while applying a high state (+24V) to **DI2** will activate the braking option.

Table 7.1. Configuration parameters for the "Backspin control" function and DC braking

Parameter	Description
11.02	Operating mode Setting: 002 Vector s. less, 003 Vector sensor
11.20	Stop mode. Setting: 002 BSC
11.43	Phase loss Setting: 001 Yes
11.50	DC breaking voltage. Range: 0.0..40.0% motor's Un Factory setting: 0.5%
11.51	DC breaking time Range: 0.0..320.0 s Factory setting: 2.0 s
11.52	Enable of DC braking Setting: 531 Enable (permanent) or turning on by digital inputs 001 DI1 .. 010 DI10
11.53	DC breaking current Range: 0.0..120% of motor's current Factory setting: 50.0%
17.01	Backspin Enable Setting: 001 Yes
17.02	Backspin acceleration Range: 0.0..320.0 s. Factory setting: 20 s
17.03	Minimal output frequency of backspin controller Range: 0.5..20.0 Hz. Factory setting: 2.0 Hz
17.04	Maximum output frequency of backspin controller Range: 1.0..50.0 Hz. Factory setting: 10.0 Hz
17.05	Kp of BSC speed controller Range: 1.0..3200.0%. Factory setting: 100.0%
17.06	Ti of BSC speed controller Range: 1.0..3200.0%. Factory setting: 100.0%
17.07	Kp of BSC torque controller Range: 1.0..3200.0%. Factory setting: 100.0%
17.08	Ti of BSC torque controller Range: 1.0..3200.0%. Factory setting: 100.0%
17.09	Minimum of Udc (DC link voltage) in Backspin control mode Range: 0..900V. Factory setting: 610V
17.10	Maximum of Udc (DC link voltage) in Backspin control mode Range: 0..900V. Factory setting: 710V
17.12	The value of the torque when the drive will stop. Active when par. 11.20 = 002 BSC . Range: -20.0%..30.0%. Factory setting: 10%
17.13	Service parameter

8. Control of the frequency converter by communications channels

Frequency converter MFC810/MFC1000 is equipped with RS-485 communication link and Ethernet – fig. 8.1. It can be equipped with other communication standards as ordered when using optional expansion cards.

The communication channel number	Communication type	Description	Parameter group number
Channel 1 (CH1)	Modbus RTU (RS-485)	Pins: 32,33,34;	Group 45
Channel 2 (CH2)	Modbus RTU (RS-485), CAN, other possibilities	Additional communication module in Slot 0	Group 46
Channel 3 (CH3) ¹⁾	Modbus RTU (RS-485)	Pins: 35,36,37 or an additional communication module in one of the slots: 1, 2, 3, 4	Group 47
	Modbus TCP	Port Ethernet	

¹⁾ The type of communication on channel 3 depends on the settings of micro-switches JP3 and JP4 – see table 8.1.

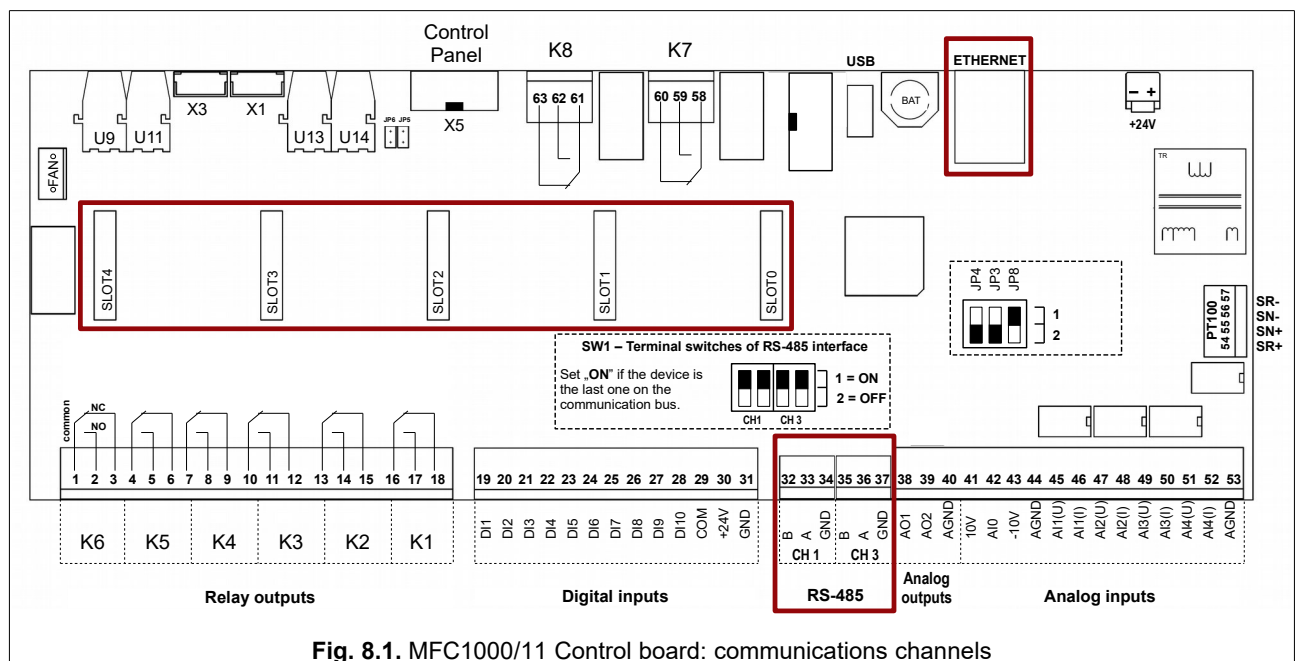

Micro-switch JP8 can be used only for a diagnostic tasks. In normal work mode it should be set at 1.

Table 8.1. Setting of the communication channel 3 (CH3)

Ethernet: (Modbus TCP)	JP4 = 1 JP3 = 1 Parameter 47.01 = 2	RS-485: (Modbus RTU)	JP4 = 2 JP3 = 2 Parameter 47.01 = 0 or 1
---------------------------	---	-------------------------	--

It enables to control work of device with help of a computer or an external controller. The basic characteristics and possibilities of the RS link of the frequency converter:

- operation with speed 9600, 19200, 38400, 57600 or 115200 bits per second,
- a format of a character: 8 data bits, lack of parity control, 2 stop bits,
- transfer protocol: MODBUS mode RTU,
- check of transfer validity with use of CRC sum,
- unit number (converter) set up with help of parameter (typically 12),
- support of MODBUS commands: command 3 - "read the register" - allows to read individual registers from the converter or block of up to 127 registers. command 6 - "register write" - write to individual register in the converter,
- possibility of reading of an operating mode, control start/stop, reading and writing of referencing-units,
- possibility of reading and writing of all parameters of the converter just as by means of a control panel,
- possibility of reading all 512 PCH and writing 64 of them, which are intended for writing through RS connection.

All operations are based on two basic commands of MODBUS RTU protocol - 3 and 6 which are described in publications concerning MODBUS.

8.1. Parameters for communication channels

Table 8.2. Communication parameters

Parameter / Name	Function	Available options / measurement unit	Factory setting	Change during operation
Group 45 – Communication channel №1				
45.01 Protocol	Protocol selection	0 Modbus RTU - RS-485 1 Modbus RTU Master - RS-485	0	Yes
Modbus RTU (CH1) communication parameters:				
45.02 Speed	Transmission speed	000 2400 001 4800 002 9600 003 19200 004 38400 005 57600 006 115200	002 9600	Yes
45.03 Parity	Parity	0, 1	0	Yes
45.04 Stop bits	Stop bits	0, 1	0	Yes
45.05 Terminator	Terminator	0, 1	0	Yes
45.06 Timeout	Timeout	0 .. 600 s	30 s	Yes
45.07 Tout react	Reaction to the lack of RS-485 communication	000 None – no response 001 Warning - a warning will be displayed, device keeps working with set frequency 002 Fault - device will stop and message will be displayed 003 Last freq. - a warning will be displayed, the frequency will be at the average level of the last 10 seconds 004 Const freq. 15 - the system will work with frequency Fconst. 15	000 None	Yes
Group 46 – Communication channel №2				
46.01 Protocol	Protocol selection	0 Modbus RTU - RS-485 1 Modbus RTU Master - RS-485 2 CAN	0	Yes
Modbus RTU (CH2) communication parameters				
46.02 Speed	Transmission speed	000 2400 001 4800 002 9600 003 19200 004 38400 005 57600 006 115200	002 9600	Yes
46.03 Parity	Parity	0, 1	0	Yes
46.04 Stop bits	Stop bits	0, 1	0	Yes
46.05 Terminator	Terminator	0, 1	0	Yes
46.06 Timeout	Timeout	0 .. 600 s	30 s	Yes
46.07 Tout react	Reaction to the lack of RS-485 communication	000 None – no response 001 Warning - a warning will be displayed, device keeps working with set frequency 002 Fault - device will stop and message will be displayed 003 Last freq. - a warning will be displayed, the frequency will be at the average level of the last 10 seconds 004 Const freq. 15 - the system will work with frequency Fconst. 15	000 None	Yes
CAN (CH2) communication parameters				
46.10	CAN ID	1..127	12	Yes ¹⁾
46.11	CAN transmission speed	000 50 kbit 001 100kbit 002 125 kbit 003 250 kbit 004 500 kbit 005 1000 kbit	004 500 kbit	Yes ¹⁾
46.12	CAN Profile	000 CiA 402 011 USER1	000 CiA 402	Yes ¹⁾

1) The frequency converter must be restarted

Parameter / Name	Function	Available options / measurement unit	Factory setting	Change during operation
46.20..46.96	Rpdo: cobld, type, event time; Tpdo: cobld, type – see appendix "Table of parameters"			Yes ¹⁾
Group 47 – Communication channel №3				
47.01 Protocol	Protocol selection	0 Modbus RTU - RS-485 1 Modbus RTU Master - RS-485 2 Modbus TCP - Ethernet	0	Yes
Modbus RTU (CH3) communication parameters				
47.02 Speed	Transmission speed	000 2400 001 4800 002 9600 003 19200 004 38400 005 57600 006 115200	002 9600	Yes
47.03 Parity	Parity	0, 1	0	Yes
47.04 Stop bits	Stop bits	0, 1	0	Yes
47.05 Terminator	Terminator	0, 1	0	Yes
47.06 Timeout	Timeout	0 .. 600 s	30 s	Yes
47.07 Tout react	Reaction to the lack of RS-485 communication	000 None – no response 001 Warning - a warning will be displayed, device keeps working with set frequency 002 Fault - device will stop and message will be displayed 003 Last freq. -a warning will be displayed, the frequency will be at the average level of the last 10 seconds 004 Const. freq. 15 - the system will work with frequency Fconst. 15	000 None	Yes
Modbus TCP (CH3) communication parameters				
47.10 ETH IP 1	The first part of the address IP	0 .. 255, for example. 192.168.1.50	192	Yes
47.11 ETH IP 2	The second part of the address IP	0 .. 255, for example. 192. 168 .1.50	168	Yes
47.12 ETH IP 3	Third part of the address IP	0 .. 255, for example. 192.168. 1.50	1	Yes
47.13 ETH IP 4	The fourth part of the address IP	0 .. 255, for example. 192.168.1.. 2		Yes
47.14 ETH MASK 1	The first part of the subnet mask	0 .. 255, for example. 255.255.255.0	255	Yes
47.15 ETH MASK 2	The second part of the subnet mask	0 .. 255, for example. 255. 255 .255.0	255	Yes
47.16 ETH MASK 3	The third part of the subnet mask	0 .. 255, for example. 255.255. 255 .0	255	Yes
47.17 ETH MASK 4	The fourth part of the subnet mask	0 .. 255, for example. 255.255.255. 0	0	Yes
47.18 ETH GW 1	The first part of the network gateway address	0 .. 255, for example. 192.168.1.1	192	Yes
47.19 ETH GW 2	The second part of the gateway address	0 .. 255, for example. 192. 168 .1.1	168	Yes
47.20 ETH GW 3	Third part of the gateway address	0 .. 255, for example. 192.168. 1 .1	1	Yes
47.21 ETH GW 4	The fourth part of the gateway address	0 .. 255, for example. 192.168.1. 1	1	Yes
47.22 ETH port	Port Ethernet	0 .. 65535	502	Yes
47.23 ETH dhcp	DHCP	0: No 1: Yes	No	Yes
47.24 ETH timeout	Permissible connection loss time TCP	0 .. 600 s	300 s	Yes

CAUTION: If control RS blocked (par. 40.07) and parameters 20.10, 20.11, 20.20, 20.21, 20.30, 20.31, 20.40, 20.41 define control as "RS" in this case the frequency converter remains in STOP mode or the referencing-unit of frequency will assume value 0.

1) The frequency converter must be restarted

8.2. Map of registers accessible through communications channels

All registers are 16-bit numbers. Addresses which are omitted in the table are not supported.

Table 8.3. Registers

The address of the registers (decimal)	Description (meaning)	Mode
PCH REGISTERS -see. Appendix "Characteristic Points PCH"		
1000..1699	PCH from number 0 up to number 699	Read only
1700..1749	PCH from number 700 up to number 749 - intended for writing	Read / write
1750..1769	PCH from number 750 up to number 769 - intended for writing (parameter group 49)	Read / write
1770..1789	PCH from number 770 up to number 789 - intended for reading (parameter group 49)	Read only
1790..1999	PCH from number 790 up to number 999	Read only

The address of the registers (decimal)	Description (meaning)	Mode
REGISTERS OF OPERATING MODES		
2000	<p>The register RS CONTROL. The data is valuable only when the parameter 40.07 (RS permission) allows control of the device with RS. Bits meaning:</p> <ul style="list-style-type: none"> bits 0: not used bits 1: the sequence 0 → 1 → 0 erases the message on failure bits 2,3: not used bits 4: not used bits 5: not used bits 6: not used bits 7,8,9,10,11: not used bits 12: 1=BLOCKING of OPERATION shut down according to Parameter bits 13: 1=BLOCKING of OPERATION shut down RAMP bits 14: 1=BLOCKING of OPERATION shut down RUN OUT bits 15: 1=START, 0=STOP <p>Bits 12,13,14 block operation of the drive irrespective of the established type of control (also when, for example, there is control through RS and bits 15=1).</p>	<p>Read / write</p> <p>The last value written down in this register can be read.</p>
2001	<p>SPEED REFERENCE</p> <p>The RS frequency or rpm referencing-unit operates only if the parameter 40.07 (RS permission) allows operation with BUS.</p> <p>For par. 21.10 Resolution 0,1Hz^{*)}, a range -5000..5000. e.g. 250 = 25.0 Hz clockwise rotation (par. 21.20 = 0, resolution 0.1Hz) e.g. -122 = 12.2 Hz anti-clockwise rotation</p> <p>^{*)} For a mode of vector control (the Vector 1 and Vector2) value is in rotations per one minute (rpm) instead of in Hz.</p>	Read / write
2002	<p>The referencing-unit of the PID controller operates only if the parameter 40.07 (RS permission) allows operation with RS.</p> <p>Resolution 0,1 %, a range 0..1000, e.g. 445 = 44,5 %.</p>	Read / write
2003	<p>Forcing state of digital inputs. The register intended for testing. If bits 15 of this register is set up, bits 0..5 determines a state of a digital input 1..6 of electric drives (state on a real digital input is ignored).</p>	Read / write

The address of the registers (decimal)	Description (meaning)	Mode																															
2004	<p>STATE OF CONTROL – the register containing information about the source of the START/STOP signal and speed reference.</p> <p>Bits 0,1: main control A1/A2, B1/B2</p> <table border="1" data-bbox="371 286 1321 322"> <tr> <td>0: A1</td> <td>1: A2</td> <td>2: B1</td> <td>3: B2</td> </tr> </table> <p>Bits 2,3,4: referencing-unit of frequency</p> <table border="1" data-bbox="371 371 1321 450"> <tr> <td>0: other</td> <td>1: keypad</td> <td>2: motopotentiometer</td> <td>3: PID</td> </tr> <tr> <td>4: RS</td> <td>5: analog input</td> <td>6: other then RS</td> <td>---</td> </tr> </table> <p>Bits 5,6,7 (0..7) - determining the chosen in bits 2,3,4 referencing-unit of frequency</p> <p>2: motopotentiometer:</p> <table border="1" data-bbox="608 539 1082 618"> <tr> <td>1: motopotentiometer 1</td> <td>2: motopotentiometer 2</td> </tr> <tr> <td>3: motopotentiometer 3</td> <td>4: motopotentiometer 4</td> </tr> </table> <p>3: PID:</p> <table border="1" data-bbox="608 667 1082 745"> <tr> <td>1: PID 1</td> <td>2: PID 2</td> </tr> <tr> <td>3: PID 3</td> <td>4: PID 4</td> </tr> </table> <p>5: analog input:</p> <table border="1" data-bbox="608 786 1082 864"> <tr> <td>1: analog input 1</td> <td>2: analog input 2</td> </tr> <tr> <td>3: analog input 3</td> <td>4: analog input 4</td> </tr> </table> <p>6: other then RS - for communication other then RS input reference:</p> <table border="1" data-bbox="608 904 1082 983"> <tr> <td>1: communication 1</td> <td>2: communication 2</td> </tr> <tr> <td>3: communication 3</td> <td>---</td> </tr> </table> <p>Bits 8,9,10: Start/Stop source:</p> <table border="1" data-bbox="371 1032 1321 1068"> <tr> <td>0: keypad</td> <td>1: communication channel</td> <td>2..5: remote 1..4</td> </tr> </table> <p>Bits 11..15 - reserved</p>	0: A1	1: A2	2: B1	3: B2	0: other	1: keypad	2: motopotentiometer	3: PID	4: RS	5: analog input	6: other then RS	---	1: motopotentiometer 1	2: motopotentiometer 2	3: motopotentiometer 3	4: motopotentiometer 4	1: PID 1	2: PID 2	3: PID 3	4: PID 4	1: analog input 1	2: analog input 2	3: analog input 3	4: analog input 4	1: communication 1	2: communication 2	3: communication 3	---	0: keypad	1: communication channel	2..5: remote 1..4	Read only
0: A1	1: A2	2: B1	3: B2																														
0: other	1: keypad	2: motopotentiometer	3: PID																														
4: RS	5: analog input	6: other then RS	---																														
1: motopotentiometer 1	2: motopotentiometer 2																																
3: motopotentiometer 3	4: motopotentiometer 4																																
1: PID 1	2: PID 2																																
3: PID 3	4: PID 4																																
1: analog input 1	2: analog input 2																																
3: analog input 3	4: analog input 4																																
1: communication 1	2: communication 2																																
3: communication 3	---																																
0: keypad	1: communication channel	2..5: remote 1..4																															
2006	<p>OPERATION STATE</p> <p>Value of this register serves for identification of the device's state:</p> <p>bits 0: 1=the drive operates</p> <p>bits 1: 1=one of referencing-units of a control panel (frequency, the PID controller or the user's referencing-unit) is switched ON</p> <p>bits 2: 1=device is blocked</p> <p>bits 3: 1=ready to restart (failure message was erased, but the reason has not disappeared)</p> <p>bits 4,5,6: number of automatic restart/number of a stage of identification</p> <p>bits 7: CRC error in EEPROM</p> <p>bits 8,9,10,11,12: a failure code or warning (0 = absence of failure)</p> <p>bits 13: value of a failure code: 0 = failure, 1 = warning)</p> <p>bits 14: a direction of operation (0 = to the right, 1 = to the left).</p> <p>bits 15: 1=identification (it is started by par. 10.20)</p>	Read only																															
THE REGISTERS CONNECTED TO PARAMETERS																																	
4XXYY	<p>XX-number of group, YY number of parameter</p> <p>Example: par.00.01 → 40001d</p> <p>par.20.11 → 42011d</p>	Read / write (depending on the par. group)																															

8.3. Handling of connection errors

If connection errors appear or if the command with improper parameter is sent, response of the device is described by MODBUS standard. Possible return error codes are:

- 1 = unknown command - when the command other than 3 or 6 is sent,
- 2 = wrong address - the address of the register is not supported by the electric drive (there is no such register),
- 3 = wrong value - command 6 tried to send value which is out of range of specified register

In case of wrong transfer (e.g. CRC error), device does not send answers to commands.

9. Table of Functions of Universal Blocks

Each Universal Block has 3 inputs which have been marked A, B and C. These inputs can be pointers or parameters. In the table below the following convention of type denoting is used: A (big letter A) means that input **A** is a parameter (value is assigned directly to it), but **a** (the small letter a) means that the input **a** is a pointer (it points PCH which contains the input value). Inputs B and C are marked in the same way.

Caution: In OUT which is interpreted as logic value (0/1 or not/yes) abbreviation **H** is used for definition of any value different from zero (logic 1). For definition of "logic 0" value character **L** is used.

Table 9.1. Functions of Universal Blocks

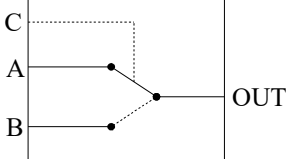
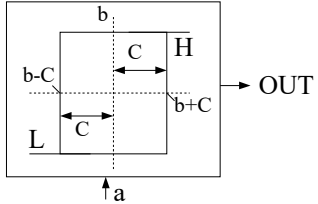
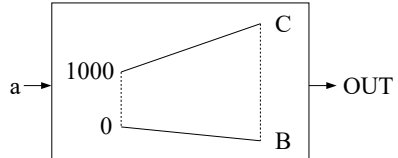
Function number	Output (OUT of the block)	Description
0	a	Output OUT assumes a value which is defined by an input a . It serves for storing values which are quickly changed – for 10ms after execution of this block, value of output PCH will not change even if the input value changes.
1	$a + b + c$	Value OUT of the unit is the sum of three pointers a , b and c
2	$a * b / c$	Product a * b divided by value c
3	NEG (a + b)	OUT of the unit = - (a + b) (the sum negation)
4	ABS (a + b)	OUT of the unit = an absolute value of (a + b)
5	$a + b - c$	OUT of the unit = a + b - c
6	$b \leq a \leq c$	Limitation of an output range. Output signal of the unit is between b (minimum) and c (maximum) according to the rules described below: If (a < b) → OUT = b If (a ≥ b) or (a ≤ c) → OUT = a If (a > c) → OUT = c
7	$B \leq a \leq C$	The same as item 6 but B and C are the constant parameters
8	$a + B$	OUT = a + B , B is the parameter (e.g. addition of a constant offset)
9	If c = H , OUT = b If c = L , OUT = a	The multiplexer 1 from 2. Logic state of an input decides about the output value a or b . 
10	If (a ≥ B), OUT = a If (a < B), OUT = c	If value of an input a is equal or higher than a threshold determined by input B , an output value a will be assumed. If value of an input a is less than threshold determined by input B , an output value c will be assumed.
11	$a \geq (b * C)$	OUT = H when the inequality is carried out, OUT = L in all other cases
12	$a \geq (b + C)$	OUT = H when the inequality is carried out, OUT = L in all other cases
13	$a = (b +/- C)$	OUT = H when value is in the limits <b-C... b+C> , OUT = L in all other cases
14	If (a < b - C), OUT = L If (a > b + C), OUT = H	A hysteresis. The output signal doesn't change for a which is within the range <b-C... b+C> 
15	$B + a * (C - B) / 1000$	Graduation. The input value a will be transformed from a range 0...1000 (0.0...100.0 %) to a range determined by the parameters B and C 

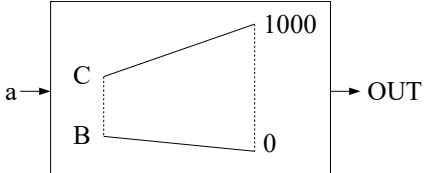
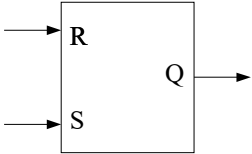
Function number	Output (OUT of the block)	Description																																				
16	$(a - B) * 1000 / (C - B)$	<p>Graduation. The input value a will be transformed from a range determined by the parameters B and C to a range 0...1000 (0.0...100.0 %)</p> 																																				
17	If (a = H) OUT = b. If (a = L) OUT remains without changes.	Value OUT of the unit changes only if there is the value H on an a input.																																				
18	a OR b OR c	<p>OUT of the unit is the logical sum of the inputs a, b and c values. CAUTION: it is not an operation on bits! (0 means an input = 0, 1 means an input ≠ 0).</p> <table border="1" data-bbox="655 685 1481 1061"> <thead> <tr> <th>a</th> <th>b</th> <th>c</th> <th>OUT</th> </tr> </thead> <tbody> <tr><td>0</td><td>0</td><td>0</td><td>0</td></tr> <tr><td>0</td><td>0</td><td>1</td><td>1</td></tr> <tr><td>0</td><td>1</td><td>0</td><td>1</td></tr> <tr><td>0</td><td>1</td><td>1</td><td>1</td></tr> <tr><td>1</td><td>0</td><td>0</td><td>1</td></tr> <tr><td>1</td><td>0</td><td>1</td><td>1</td></tr> <tr><td>1</td><td>1</td><td>0</td><td>1</td></tr> <tr><td>1</td><td>1</td><td>1</td><td>1</td></tr> </tbody> </table>	a	b	c	OUT	0	0	0	0	0	0	1	1	0	1	0	1	0	1	1	1	1	0	0	1	1	0	1	1	1	1	0	1	1	1	1	1
a	b	c	OUT																																			
0	0	0	0																																			
0	0	1	1																																			
0	1	0	1																																			
0	1	1	1																																			
1	0	0	1																																			
1	0	1	1																																			
1	1	0	1																																			
1	1	1	1																																			
19	a AND b AND c	<p>OUT of the unit is logic product of the inputs a, b and c values</p> <table border="1" data-bbox="655 1111 1481 1487"> <thead> <tr> <th>a</th> <th>b</th> <th>c</th> <th>OUT</th> </tr> </thead> <tbody> <tr><td>0</td><td>0</td><td>0</td><td>0</td></tr> <tr><td>0</td><td>0</td><td>1</td><td>0</td></tr> <tr><td>0</td><td>1</td><td>0</td><td>0</td></tr> <tr><td>0</td><td>1</td><td>1</td><td>0</td></tr> <tr><td>1</td><td>0</td><td>0</td><td>0</td></tr> <tr><td>1</td><td>0</td><td>1</td><td>0</td></tr> <tr><td>1</td><td>1</td><td>0</td><td>0</td></tr> <tr><td>1</td><td>1</td><td>1</td><td>1</td></tr> </tbody> </table>	a	b	c	OUT	0	0	0	0	0	0	1	0	0	1	0	0	0	1	1	0	1	0	0	0	1	0	1	0	1	1	0	0	1	1	1	1
a	b	c	OUT																																			
0	0	0	0																																			
0	0	1	0																																			
0	1	0	0																																			
0	1	1	0																																			
1	0	0	0																																			
1	0	1	0																																			
1	1	0	0																																			
1	1	1	1																																			
20	a XOR b	<p>OUT of the unit is the result of XOR operation (exclusive OR) on inputs a and b</p> <table border="1" data-bbox="655 1559 1481 1765"> <thead> <tr> <th>a</th> <th>b</th> <th>OUT</th> </tr> </thead> <tbody> <tr><td>0</td><td>0</td><td>0</td></tr> <tr><td>0</td><td>1</td><td>1</td></tr> <tr><td>1</td><td>0</td><td>1</td></tr> <tr><td>1</td><td>1</td><td>0</td></tr> </tbody> </table>	a	b	OUT	0	0	0	0	1	1	1	0	1	1	1	0																					
a	b	OUT																																				
0	0	0																																				
0	1	1																																				
1	0	1																																				
1	1	0																																				
21	NOT (a OR b OR c)	OUT of the unit is inversion of logical sum of values a , b and c . (NOR)																																				
22	NOT (a AND b AND c)	OUT of the unit is inversion of logical product of values a , b and c . NAND).																																				
23	NOT (a)	Logic inversion of an input value a .																																				
24	According to Truth Table a = R, b = S	<p>Trigger RS. Input R has the priority.</p>  <table border="1" data-bbox="1289 1921 1474 2114"> <thead> <tr> <th>R</th> <th>S</th> <th>OUT</th> </tr> </thead> <tbody> <tr><td>0</td><td>0</td><td>n-1</td></tr> <tr><td>0</td><td>1</td><td>1</td></tr> <tr><td>1</td><td>0</td><td>0</td></tr> <tr><td>1</td><td>1</td><td>0</td></tr> </tbody> </table>	R	S	OUT	0	0	n-1	0	1	1	1	0	0	1	1	0																					
R	S	OUT																																				
0	0	n-1																																				
0	1	1																																				
1	0	0																																				
1	1	0																																				

Function number	Output (OUT of the block)	Description																																
25	According to Truth Table a = D, b = CLK, c = R	<p>Trigger D (Latch)</p> <table border="1" style="float: right;"> <thead> <tr> <th>R</th> <th>D</th> <th>CLK</th> <th>OUT</th> </tr> </thead> <tbody> <tr> <td>0</td> <td>0</td> <td>0</td> <td>n-1</td> </tr> <tr> <td>0</td> <td>0</td> <td>1</td> <td>n-1</td> </tr> <tr> <td>0</td> <td>0</td> <td>⌈</td> <td>0</td> </tr> <tr> <td>0</td> <td>1</td> <td>⌈</td> <td>1</td> </tr> <tr> <td>0</td> <td>1</td> <td>0</td> <td>n-1</td> </tr> <tr> <td>0</td> <td>1</td> <td>1</td> <td>n-1</td> </tr> <tr> <td>1</td> <td>X</td> <td>X</td> <td>0</td> </tr> </tbody> </table>	R	D	CLK	OUT	0	0	0	n-1	0	0	1	n-1	0	0	⌈	0	0	1	⌈	1	0	1	0	n-1	0	1	1	n-1	1	X	X	0
R	D	CLK	OUT																															
0	0	0	n-1																															
0	0	1	n-1																															
0	0	⌈	0																															
0	1	⌈	1																															
0	1	0	n-1																															
0	1	1	n-1																															
1	X	X	0																															
26	Current value of the counter a = CLK, b = CLR, c = DIR Note: the output of this counter can assume positive and negative values in range <-32768...32767>.	<p>The counter with reset and direction inputs. The minimal period for CLK is 20ms. It concerns all counters.</p>																																
27	Current value of the counter: a = CLK, b = SET, c = initial value	<p>“One shot” counter type, counting down with an input setting on initial value (SET) and an input of initial value.</p>																																
28	Current value of the counter a = CLK, b = ENABLE, c = max value	<p>The modulo «up» counter with an input of max value and with an input of the account permission ENABLES</p>																																
29	$f_{out} = f_{in} / (2^*C)$; a = f_{in} , b = ENABLE, C = the divider	<p>The divider of frequency with ENABLE input.</p>																																
30	Current value of the counter a = CLK, b = ENABLE, c = NOT (CLR)	<p>The counter "up" with an input of permission ENABLE and resetting by inverting. Caution: after overflow (max = 65535) the counter starts with null.</p>																																

Function number	Output (OUT of the block)	Description																																				
31	0...7 depends on the state of the inputs a, b, c	The binary decoder. It replaces binary coded number with a decimal number in a band <0...7> according to the table.																																				
		<table border="1"> <thead> <tr> <th>a</th> <th>b</th> <th>c</th> <th>OUT</th> </tr> </thead> <tbody> <tr> <td>0</td> <td>0</td> <td>0</td> <td>0</td> </tr> <tr> <td>1</td> <td>0</td> <td>0</td> <td>1</td> </tr> <tr> <td>0</td> <td>1</td> <td>0</td> <td>2</td> </tr> <tr> <td>1</td> <td>1</td> <td>0</td> <td>3</td> </tr> <tr> <td>0</td> <td>0</td> <td>1</td> <td>4</td> </tr> <tr> <td>1</td> <td>0</td> <td>1</td> <td>5</td> </tr> <tr> <td>0</td> <td>1</td> <td>1</td> <td>6</td> </tr> <tr> <td>1</td> <td>1</td> <td>1</td> <td>7</td> </tr> </tbody> </table>	a	b	c	OUT	0	0	0	0	1	0	0	1	0	1	0	2	1	1	0	3	0	0	1	4	1	0	1	5	0	1	1	6	1	1	1	7
		a	b	c	OUT																																	
		0	0	0	0																																	
		1	0	0	1																																	
		0	1	0	2																																	
		1	1	0	3																																	
		0	0	1	4																																	
		1	0	1	5																																	
0	1	1	6																																			
1	1	1	7																																			
32	Positive or negative impulse a = TRIG (down-up transition), $T_{imp} = B * 5 * T + T$, C = polarity	Caution: the minimal duration of triggering impulse TRIG is $1 * T$. Impulse on OUT is maximally $1 * T$ delayed in comparison with TRIG signal. The next use of the generator isn't possible until termination of current impulse.																																				
33	Pulse is positive or negative	It is analogous to function 32. Difference: inputs b and c are pointers - it is possible to change a pulse duration and its polarity in PLC operating mode.																																				
34	Generator signal a = ENABLE, B, C – times (periods)	$T_{on} = B * T$, $T_{off} = C * T$																																				
35	Impulse delayed a = input impulse, B, C – delay times	$T_{op1} = B * T$, $T_{op2} = C * T$ Detection of the next pulse begins in points W1 and W2.																																				
36	Switch on / switch off function with delayed shut down a = switching on impulse (leading edge) b = switching off impulse (leading edge) C = delay on shut down	$T_{op} = C * T$																																				
37	Switch on / switch off function with delayed switching on a = switching on impulse (leading edge) b = switching off impulse (leading edge) C = delay on switching on	$T_{op} = C * T$. If the pulse b appears in time T_{op} , switching on will not take place.																																				

*T = par 5.145 x 0.2 ms

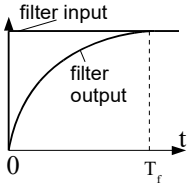
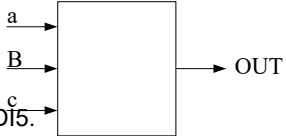
Function number	Output (OUT of the block)	Description
38	The filter of analog signals a, b - inputs of the filter C - the constant of the filter	Sum (a+b) is taken as input value of the filter. $T_f = C * T$ 
39	Fast counter a - quantity of impulses for counting B - a multiplier c - restart	The counter converts pulses from digital input DI5. The maximum frequency of converted impulses is 2 kHz. The unit can be used only once in structure of the program. If $i_i < (a * B) \rightarrow OUT = L$ If $i_i \geq (a * B) \rightarrow OUT = H$ If $c \neq 0 \rightarrow OUT = H$ i_i - quantity of the impulses counted from input DI5. Update of the OUT output each T period. 
40	Sequencer inputs – not active	Look at sequencer description – section 12.2
41	Multiplexer 1 inputs – not active	Look at multiplexer description – section 12.3
42	Multiplexer 2 inputs – not active	Look at multiplexer description – section 12.3
43	Unit of curve formation	Look at description of the unit of curve formation – section 12.4
46	Modbus reading A – frequency converter No. B - registry address	The block output takes the value read via modbus from the address number B in the device with number A - see tab. 8.3 on page 36. Note: only the master device (unit with number = 0) can make a reading.
47	Modbus writing A – frequency converter No. B - registry address c - PCH	The system via modbus saves the value from PCH specified by parameter "c" in the device with the number A at address B - see from tab. 8.3 on page 36. Note: only the master device (unit with number = 0) can make a writing.

*T = par 5.145 x 0.2 ms

10. Failures and warnings codes

Failure/ warning code (CANopen)	Displayed name	Description	Possible reason	Counteraction	Status
100...200: control circuits errors					
101 (6200h)	Program error 1	Program error: ST	Corrupted program memory, external electromagnetic disturbance.	Turn the power off and on again. Contact service.	Failure
102 (6200h)	Program error 2	Program error: VSD			Failure
103 (6200h)	Program error 3	Program error: AcR			Warning
110 (6310h)	EEPROM CRC error	Parameters memory error	Corrupted parameter memory, external electromagnetic disturbance.	Turn the power off and on again. Upload factory parameters. Contact service	Warning Failure
111 (6200h)	No VSD data	Missing data from VSD module	Missing/wrong connection between control board and VSD board.	Turn the power off and on again. Check connection between boards. Contact service.	Failure
112 (6200h)	No ACR data	Missing data from ACR module	Missing/wrong connection between control board and ACR board.	Turn the power off and on again. Check connection between boards. Contact service	Failure
120 (7500h)	No keypad	Failure of the communication with Control panel	Damage of the control panel or connecting cable.	Check connections: wires, plugs.	Warning Failure
121 (7500h)	Comm. err. VSD	Lack of communication with VSD module	Failure of the VSD module or internal connection cable.	Contact service.	Failure
122 (7500h)	Comm. err. ACR	Lack of communication with AcR module	Failure of the AcR module or internal connection cable.		Warning
123 (7500h)	Comm. error „1”	Communication canal 1 failure	Failure of a cable, parameters of the transmission are incorrectly set up.	Check external connections and validity of communication canals parameters.	Warning Failure
124 (7500h)	Comm. error „2”	Communication canal 2 failure	Failure of a cable, parameters of the transmission are incorrectly set up.	Check external connections and validity of communication canals parameters.	Warning Failure
125	Comm. error „3”	Communication canal 3 failure	Failure of a cable, parameters of the transmission are incorrectly set up.	Check external connections and validity of communication canals parameters.	Warning Failure
130 (FF80h)	Identification run value wrong	Parameters acquired during motor identification exceeded possible highest value	Wrong motor parameters. Wrong used motor.	Check motor parameters, run identification again.	Failure
135 (6320h)	EEPROM save not ok	Control board can't save parameters to eeprom	External electromagnetic disturbance, EEPROM damage.	Turn the power off and on again. Set default values. Contact service.	Failure

Failure/warning code (CANopen)	Displayed name	Description	Possible reason	Counteraction	Status
136 (6320h)	EEPROM load not ok	Program can't load parameters from eeprom	External electromagnetic disturbance, EEPROM damage.	Turn the power off and on again. Set default values. Contact service.	Failure
141 (FF00h)	Motor lack	Motor isn't connected with inverter		Check connection with inverter. Check parameters 10.03, 30.26.	Warning Failure
144 (FF01h)	Curr. sens. missing	Current sensor missing	Connection with current sensor missing/damaged.	Check connection. Contact service.	
150 (5111h)	VCC VSD error	Improper supply voltage of the measuring circuit controlling of the motor	Motor controller circuit fault.		Failure
155 (5111h)	VCC ACR error	Improper supply voltage of the measuring circuit controlling of the Active Rectifier	Active rectifier controller circuit fault.	Contact service.	Warning
180 (7305h)	Encoder error	Encoder error	Encoder failure or connecting wires.		Warning
200...300: electric motor circuits errors					
201 (4200h)	High Temp.1	Temperature of the IGBT module 1 is higher than 95°C			Warning
202 (4200h)	High Temp.2	Temperature of the IGBT module 2 is higher than 95°C	Difficult flow of coolant. Overloading. Too high ambient temperature.	Check the cooling efficiency (efficiency of the cooling fan and pollution of a heatsink). Lower the ambient temperature.	Warning
203 (4200h)	High Temp.3	Temperature of the IGBT module 3 is higher than 95°C			Warning
205 (FF02h)	No temp. sensor	No signal from IGBT module temperature sensor			Failure of the internal IGBT temperature sensor or connection wire.
206 (FF03h)	Short circ. temp. sens.	Short circuit in IGBT module temperature sensor			
211 (4200h)	Too high Temp.1	Temperature of the IGBT module 1 is higher than 100°C	Hindered flow of air of FC. Overloading. Too high ambient temperature.	Check the cooling efficiency (efficiency of the cooling fan and pollution of a heatsink). Lower the ambient temperature.	Failure
212 (4200h)	Too high Temp.2	Temperature of the IGBT module 2 is higher than 100°C			
213 (4200h)	Too high Temp.3	Temperature of the IGBT module 3 is higher than 100°C			
217 (7520h)	VSD comm. error 2	Communication failure of the VSD module	Failure of the VSD module or connection wire	Contact service	Failure
220 (3211h)	High UDC hardware	High voltage in DC circuit - hardware notification	Too high voltage in the circuit. Too intensive braking of the electric motor.	Check the supply voltage. Increase a time of deceleration in(par. 13.02 or 13.11.	Failure

Failure/warning code (CANopen)	Displayed name	Description	Possible reason	Counteraction	Status
221 (3212h)	High UDC software 1	High voltage in DC circuit - software notification		Deactivate the parameter 13.20 (setting 0.0) or increase its value.	Failure
222 (3212h)	High UDC software 2	High voltage in DC circuit - software notification			Failure
223 (3212h)	High UDC software 3	High voltage in DC circuit - software notification			Failure
230 (4310h)	High temp. Motor	Electric motor temperature reached I or II threshold	Hindered flow of air of an electric motor. Too high ambient temperature.	Check loading of the motor – current of the motor. Additional cooling fan may be required at low speeds of the electric motor.	Warning
231 (4310h)	Too high motor temp.	Electric motor temperature reached III threshold	Working on an overloaded engine or long operating time at heavy load and low speed.		Failure
240 (2300h)	High current 1	The output current of the FC is to high - hardware notification	Too high intensity of acceleration of an electric motor. A sudden change of electric motor loading.	Increase an acceleration time of the electric motor.	Failure
241 (2300h)	High current 2	The output current of the FC is to high - software notification			
244 (2311h)	Inverter overload	Thermal i ² t overload of the converter	The inverter is overloaded - output current is to high (I _{out} >1.5I _n @60sec).	Reduce the electric motor load.	Failure
245 (2300h)	High current motor	Overload of the electric motor	Electric motor is overloaded - to high current.	Reduce the electric motor load.	Failure
248 (2330h)	Earthing	The sum of el. motor currents is not equal to null	Defective insulation of windings of the el. motor or connecting wires.	Check isolation resistance of the wires connecting the el. motor and the converter and isolation resistance of windings of the el. motor.	Failure
250 (2320h)	VSD IGBT driver fault	Short circuit on output of the converter or failure of VSD IGBT module	Short circuit in the el. motor or in the wires feeding the el. motor.	Disconnect the el. motor and test presence of a short circuit, if present call service to repair FC, and if is not present test isolation of wires and windings of the el. motor.	Failure
251	VSD IGBT supply				Failure
252	VSD IGBT 1", "driver fault"	Short circuit on output of the converter or failure of VSD IGBT module	Short circuit in the el. motor or in the wires feeding the el. motor.	Disconnect the el. motor and test presence of a short circuit, if present call service to repair FC, and if is not present test isolation of wires and windings of the el. motor.	Failure
253	"VSD IGBT 1", "supply"				Failure

Failure/ warning code (CANopen)	Displayed name	Description	Possible reason	Counteraction	Status
254	"VSD IGBT 2", "driver fault"	Short circuit on output of the converter or failure of VSD IGBT module	Short circuit in the el. motor or in the wires feeding the el. motor.	Disconnect the el. motor and test presence of a short circuit, if present call service to repair FC, and if is not present test isolation of wires and windings of the el. motor.	Failure
255	VSD IGBT 2", "supply"				Failure
256	VSD IGBT U", "driver fault"	Short circuit on output of the converter or failure of VSD IGBT module	Short circuit in the el. motor or in the wires feeding the el. motor.	Disconnect the el. motor and test presence of a short circuit, if present call service to repair FC, and if is not present test isolation of wires and windings of the el. motor.	Failure
257	"VSD IGBT V", "driver fault"	Short circuit on output of the converter or failure of VSD IGBT module	Short circuit in the el. motor or in the wires feeding the el. motor.	Disconnect the el. motor and test presence of a short circuit, if present call service to repair FC, and if is not present test isolation of wires and windings of the el. motor.	Failure
258	"VSD IGBT W", "driver fault"	Short circuit on output of the converter or failure of VSD IGBT module	Short circuit in the el. motor or in the wires feeding the el. motor.	Disconnect the el. motor and test presence of a short circuit, if present call service to repair FC, and if is not present test isolation of wires and windings of the el. motor	Failure
259	"VSD IGBT BR", "driver fault"	Short circuit on output of the converter or failure of VSD IGBT module	Short circuit in the el. motor or in the wires feeding the el. motor.	Disconnect the el. motor and test presence of a short circuit, if present call service to repair FC, and if is not present test isolation of wires and windings of the el. motor.	Failure
260 (FF04h)	Output asymmetry	Asymmetrical loading	The el. motor failure or absence of output phase (damage of a wire).	Check connections of the FC - el. motor, check resistance of el. motor windings, replace the el. motor.	Warning
265 (3230h)	Underload	Operation with loading which is much lower than nominal	Parameters of a underload are incorrectly determined.	Check and correct parameter settings which refer to underload of the converter.	Warning
268 (7121h)	Stall	The el. motor has stopped under act of too high loading.	Too high anti-torque, failure of the operating device, to low power of the converter.	Check operating device (jam). Increase boost U0 voltage (par. 15.01) of the frequency converter - only in scalar mode. Reduce the load on the electric motor.	Failure

Failure/warning code (CANopen)	Displayed name	Description	Possible reason	Counteraction	Status
270 (FF05h)	F>MAX	Output frequency of the frequency converter is higher than the maximum frequency	Operation device rolls the motor up or there is a big readjustment of the speed regulator.	Modify the speed regulator settings.	Failure
275 (FF06h)	Speed control	Error of output speed - difference between reference and output speed exceed acceptable difference (par. 30.61) or time (par. 30.62).	Incorrect setting the dynamics of the drive; output values of frequency converter reached operational limits of: current, torque and/or voltage.	Check the drive system, the drive load. Change the parameters settings 30.60, 30.61, 30.62.	Warning
277 (2310h)	I2T motor 1	Overheating of the el. motor 1	Overheating of the motor or operation with high loading at small speeds.	Check loading of the motor (current of the motor); check parameters of thermal el. motor model.	Failure
278 (2310h)	I2T motor 2	Overheating of the el. motor 2	Overheating of the motor or operation with high loading at small speeds.	Check loading of the el. motor (current of the el. motor); check parameters of thermal el. motor model.	Failure
280 (FF0Ah)	Ext. block VSD	Internal failure	-	Contact service.	-
285 (FF07h)	Motor param. error	Wrong motor parameters	Parameters 10.01÷ 10.06 defined in group 10 are incorrect.	Check motor parameters entered in group 10.	Failure
290 (FF08h)	Current test	Inverter current test	Current time exceeded value from parameter 38.02.		Failure
291	VSD fan failure				Failure
295 (7112h)	Chopper Overload	Chopper temperature overloaded	Improper brake resistor. Improper brake resistor parameters.	Choose the right braking resistors. Check parameters 34.01 – 34.04.	Warning Failure
296 (7111h)	Chopper Error	Chopper IGBT driver failure		Contact service.	Failure
300...400: line circuits errors					
301 (4200h)	High Temp.ACR1	Temperature of the IGBT module 1 is higher than 100°C	Difficult flow of coolant. Overloading. Too high ambient temperature.	Check the cooling efficiency (efficiency of the cooling fan and pollution of a heatsink). Lower the ambient temperature.	Warning
302 (4200h)	High Temp.ACR2	Temperature of the IGBT module 2 is higher than 100°C			

Failure/warning code (CANopen)	Displayed name	Description	Possible reason	Counteraction	Status
303 (4200h)	High Temp.ACR3	Temperature of the IGBT module 3 is higher than 100°C			
305 (FF42h)	No temp. sensor	No signal from IGBT module temperature sensor	Failure of the internal IGBT temperature sensor or connection wire.	Contact service.	Warning
306 (FF43h)	Short cric. temp. sens.	Short circuit in IGBT module temperature sensor			
311 (4200h)	Too high temp. ACR1	Temperature of the IGBT module 1 is higher than 110°C	Difficult flow of coolant. Overloading. Too high ambient temperature.	Check the cooling efficiency (efficiency of the cooling fan and pollution of a heatsink). Lower the ambient temperature.	Warning + Stop AcR
312 (4200h)	Too high temp. ACR2	Temperature of the AcR IGBT module 1 is higher than 110°C			
313 (4200h)	Too high temp. ACR3	Temperature of the AcR IGBT module 1 is higher than 110°C			
317 (7520h)	ACR comm. error 2	Communication failure of the VSD module	Failure of the VSD module or connection wire.	Contact service.	Warning
320 (3221h)	Low DC	Low voltage in DC circuit	Low supply voltage, absence of one phase of a supply voltage.	Check a connecting cables and a supply voltage on a mains terminals.	Warning + Stop AcR
321 (3130h)	Phase missing	No one phase in the supply voltage	Absence of one phase of a supply voltage. Disconnected or damaged power supply cable.		
325 (FF44h)	Load circ. error 1	Pre-charging circuit isn't switched on	Failure in pre-charging circuit.	Check the pre-charge circuit.	Failure
326 (FF45h)	Load circ. error 2	Too long pre-charging time			Failure
330 (3211h)	High UDC hardware	High voltage in DC circuit - hardware notification	Too high voltage in the circuit. Too intensive braking of the electric motor.	Check grid voltage. Increase breaking time (delay) par 13.02 or 13.11.	Failure
331 (3212h)	High UDC software	High voltage in DC circuit - software notification			Failure
332	High UDC hardware	High voltage in half DC circuit (3lvl inverter)	-	Contact service.	Failure
333	High UDC hardware	Too much difference between capacitors (3lvl inverter)	-	Contact service.	Failure

Failure/warning code (CANopen)	Displayed name	Description	Possible reason	Counteraction	Status
340 (2100h)	High curr. grid	The input current of the FC is too high - hardware notification	Too high intensity of acceleration of an electric motor. A sudden change of electric motor loading.	Increase an acceleration time of the electric motor.	Warning + Stop AcR
341 (2100h)	High curr. grid	The input current of the FC is too high - software notification			Warning + Stop AcR
350 (2130h)	ACR IGBT driver fault	Short circuit in ACR module or incorrect work of LCL filter	Fault of the AcR module. Wrong electric circuit connection of LCL filter or fault of LCL filter.	Disconnect the electric motor and test presence of an error. Check connection of LCL filter. Contact service	Failure
360 (FF46h)	High temp. LCL filter	Internal failure	-	Contact service.	-
361 (FF47h)	Too high temp. LCL filter	Internal failure	-	Contact service.	-
365 (FF48h)	Capacitor LCL error	Internal failure	-	Contact service.	-
370 (3142h)	Grid par. fault	$f < f_{min}$	Incorrect power supply parameters.	Check a connecting cables and a supply voltage on a mains terminals	Warning + Stop AcR
371 (3141h)	Grid par. fault	$f > f_{max}$	Incorrect power supply parameters.		
372 (3120h)	Grid par. fault	$U < U_{min}$	Incorrect power supply parameters.		
373 (3110h)	Grid par. fault	$U > U_{max}$	Incorrect power supply parameters.		
374 (FF49h)	Grid par. fault	Asymmetry	Incorrect power supply parameters.		
380 (FF4Ah)	Ext. block ACR	Internal failure	-	Contact service.	-
390 (FF4Bh)	Contacto	Internal failure	-	Contact service.	-
391	ACR fan failure	AcR's fan failure			Failure
392	ACR LCL error	AcR's LCL filter failure			Failure
395	Wrong phase rotation	Wrong phase rotation	Phase connection to inverter is not in correct order.	Check grid connection to inverter.	Failure
396	Incorrect board configuration	Incorrect board configuration	Wrong jumper configuration on ACR board.	Set correct configuration. Contact service.	Failure
400...500: input/output failures					
402 (FF80h)	A1 input damaged	Damage of the analog input AI1	At input option with „living zero“ (2-10V or 4-20mA) value of a signal is lower than 1V.	Check a configuration of analog inputs, check connection circuit (damage of a cable, etc.).	Warning
403 (FF81h)	A2 input damaged	Damage of the analog input AI2			
404 (FF82h)	A3 input damaged	Damage of the analog input AI3			
405 (FF83h)	A4 input damaged	Damage of the analog input AI4			

Failure/ warning code (CANopen)	Displayed name	Description	Possible reason	Counteraction	Status
450 – 469 (FF85h- FF98h)	External 1-20	The signal of external failure is active	On the digital input specified in the parameters of group 31 has been given a voltage signal.	Check the cause of the external failure. Check the parameter settings in group 31.	Failure
470	No temp. cab. sensor	Lack of cabinet's temperature sensor	Sensor is damaged or unconnected.	Check if the sensor is working correctly. Check the sensor's wiring.	Warning
471	High temp. cabinet	The temperature inside cabinet is too high	Cabinet fans failure or hindered flow of air.	Check fans, check the cabinet air filter clogging.	Warning
480 (FF84h)	Emergency stop	Active emergency stop	The emergency stop has been activated.	Check and remove the cause of emergency stop activation. Check parameter 26.03.	Failure
490 (4220h)	Too low temperature	Temperature of the heatsink is lower than -10°C	Temperature of converter's environment is too low.	Check efficiency of heating.	Failure

11. Characteristic Points PCH

PCH	PCH name	Function / value / note
000	DISABLED	Value always = L (logical 0)
001	Input 1	State of digital input 1; L = 0V, H = 24V
002	Input 2	State of digital input 2; L = 0V, H = 24V
003	Input 3	State of digital input 3; L = 0V, H = 24V
004	Input 4	State of digital input 4; L = 0V, H = 24V
005	Input 5	State of digital input 5; L = 0V, H = 24V
006	Input 6	State of digital input 6; L = 0V, H = 24V
007	Input 7	State of digital input 7; L = 0V, H = 24V
008	Input 8	State of digital input 8; L = 0V, H = 24V
009	Input 9	State of digital input 9; L = 0V, H = 24V
010	Input 10	State of digital input 10; L = 0V, H = 24V
011..018	Input 11 .. Input 18	State of additional digital inputs 11..18 on SLOT 0; L = 0V, H = 24V
021..026	Input 21 .. Input 26	State of additional digital inputs 21..26 on SLOT 1; L = 0V, H = 24V
031..036	Input 31 .. Input 36	State of additional digital inputs 31..36 on SLOT 2; L = 0V, H = 24V
041..046	Input 41 .. Input 46	State of additional digital inputs 41..46 on SLOT 3; L = 0V, H = 24V
051..056	Input 51 .. Input 56	State of additional digital inputs 51..56 on SLOT 4; L = 0V, H = 24V
061..068	Output 1 .. Output 8	State of relay outputs K1..K8. H = it is switched ON
071..076	Output 11 .. Output 16	State of additional relay outputs K11..K16 on SLOT 0. H = it is switched ON
081..086	Output 21 .. Output 26	State of additional relay outputs K21..K26 on SLOT 1. H = it is switched ON
091..096	Output 31 .. Output 36	State of additional relay outputs K31..K36 on SLOT 2. H = it is switched ON
101..106	Output 41 .. Output 46	State of additional relay outputs K41..K46 on SLOT 3. H = it is switched ON
111..116	Output 51 .. Output 56	State of additional relay outputs K51..K56 on SLOT 4. H = it is switched ON
120	An. inp 0	Value corresponding to voltage of analog input 0. Resolution 0.1 %, range 0..1000 = 0.0..100.0 %.
121	An. inp 1	Value corresponding to voltage or current of analog input 1. Resolution 0.1 %, range 0..1000 = 0.0..100.0 %.
122	An. inp 2	Value corresponding to voltage or current of analog input 2. Resolution 0.1 %, range 0..1000 = 0.0..100.0 %.
123	An. inp 3	Value corresponding to voltage or current of analog input 3. Resolution 0.1 %, range 0..1000 = 0.0..100.0 %.
124	An. inp 4	Value corresponding to voltage or current of analog input 4. Resolution 0.1 %, range 0..1000 = 0.0..100.0 %.
130	An. inp 11	Value corresponding to voltage of additional analog input 11 on SLOT 0 Resolution 0.1 %, range 0..1000 = 0.0..100.0 %.
131	An. inp 12	Value corresponding to voltage or current of additional analog input 12 on SLOT 0 Resolution 0.1 %, range 0..1000 = 0.0..100.0 %.
132	An. inp 21	Value corresponding to voltage or current of additional analog input 21 on SLOT 1 Resolution 0.1 %, range 0..1000 = 0.0..100.0 %.
133	An. inp 22	Value corresponding to voltage or current of additional analog input 22 on SLOT 1 Resolution 0.1 %, range 0..1000 = 0.0..100.0 %.
134	An. inp 31	Value corresponding to voltage or current of additional analog input 31 on SLOT 2 Resolution 0.1 %, range 0..1000 = 0.0..100.0 %.
135	An. inp 32	Value corresponding to voltage or current of additional analog input 32 on SLOT 2 Resolution 0.1 %, range 0..1000 = 0.0..100.0 %.

PCH	PCH name	Function / value / note
136	An. inp 41	Value corresponding to voltage or current of additional analog input 41 on SLOT 3 Resolution 0.1 %, range 0..1000 = 0.0..100.0 %.
137	An. inp 42	Value corresponding to voltage or current of additional analog input 42 on SLOT 3 Resolution 0.1 %, range 0..1000 = 0.0..100.0 %.
138	An. inp 51	Value corresponding to voltage or current of additional analog input 51 on SLOT 4 Resolution 0.1 %, range 0..1000 = 0.0..100.0 %.
139	An. inp 52	Value corresponding to voltage or current of additional analog input 52 on SLOT 4 Resolution 0.1 %, range 0..1000 = 0.0..100.0 %.
140	Freq DI1	Value corresponds to the frequency on the Digital Input DI1
141	Freq DI2	Value corresponds to the frequency on the Digital Input DI2
142	Freq DI3	Value corresponds to the frequency on the Digital Input DI3
143	Freq DI4	Value corresponds to the frequency on the Digital Input DI4
144	Freq DI5	Value corresponds to the frequency on the Digital Input DI5
145	Freq DI6	Value corresponds to the frequency on the Digital Input DI6
146	Freq DI7	Value corresponds to the frequency on the Digital Input DI7
147	Freq DI8	Value corresponds to the frequency on the Digital Input DI8
148	Freq DI9	Value corresponds to the frequency on the Digital Input DI9
149	Freq DI10	Value corresponds to the frequency on the Digital Input DI10
200	Out rpm	Current rotation speed of the electric motor [rpm] - a copy of the value from the par. 0.01
201	Ref rpm	Value of the referenced rotation speed [rpm] - a copy of the value from the par. 0.02
202	Out freq	Current output frequency of the converter [Hz] - a copy of the value from the par. 0.03
203	Ref freq	Referenced frequency [Hz] - a copy of the value from the par. 0.04
210	Motor IA	RMS current of a phase A of the motor [A]. A copy of the value from the par. 0.13
211	Motor IB	RMS current of a phase B of the motor [A]. A copy of the value from the par. 0.14
212	Motor IC	RMS current of a phase C of the motor [A]. A copy of the value from the par. 0.15
213	Motor curr	Average RMS current of the motor [A]. A copy of the value from the par. 0.06
220	DC voltage	Voltage of the DC-link circuit of the converter [V]. A copy of the value from the par. 01.01
221	Grid voltage	Power line supply AC voltage [V] (estimated). A copy of the value from the par. 01.05
222	Grid freq	Line Voltage frequency [Hz]. A copy of the value from the par. 01.06
223	Grid curr L1	RMS current of a phase L1 - the power line side [A]. A copy of the value from the par. 01.09
224	Grid curr L2	RMS current of a phase L2 - the power line side [A]. A copy of the value from the par. 01.10
225	Grid curr L3	RMS current of a phase L3 - the power line side [A]. A copy of the value from the par. 01.11
230	Rotation %	Relative value which corresponds to current rotational motor speed compared to the rated motor rotation speed. Resolution 0.1 %. Value with a sign depending on direction of rotation: -1000 = -Nn, 0 = 0 rpm, 1000 = Nn
231	Out freq %	Relative value which corresponds to current output frequency of the converter compared to the rated frequency. Resolution 0.1 %. Value without a sign, it doesn't depend on direction of rotation.
232	Ref freq %	Relative value which corresponds to referred motor speed compared to rated speed.
233	Curr %	Relative value which corresponds to current output electric current compared to motor rated current. Resolution 0.1 %

PCH	PCH name	Function / value / note
234	Torq %	Relative value which corresponds to current torque of the motor compared to rated torque. Resolution 0.1 %. Value with positive sign means that the frequency converter powers the motor, negative - the frequency converter brakes the motor.
235	Power %	Relative value which corresponds to current output power of the converter compared to rated power of the drive. Resolution 0.1 %. Value with positive sign means that the frequency converter powers the drive, negative - the frequency converter breaks the motor.
236	Drive volt %	Relative value which corresponds to current output voltage of the motor compared to rated voltage. Resolution 0.1 %.
237	ACR act pow	Current reactive power of Active Rectifier block of the frequency converter compared to the active power [%]
238	ACR reac pow	Service parameter
240	Speed reg	Value of the speed regulator output
250	Temp max. VSD	The highest of the measured temperatures of VSD
251	Temp max. AcR	The highest of the measured temperatures of AcR
252	Temp. Pt100	The temperature of the Pt100 output on MFC1000/11 board
290	Temp. motor	Estimated motor temperature in %, resolution 0.1 %.
300	Keyboard ref.	Value of the local referencing-unit (keyboard). Resolution 0.1 Hz. e.g. 500 = 50.0 Hz, range is determined by parameters 2.11 and 2.12
301	PID out 1	Output of PID 1 controller. resolution 0.1 %, range is determined by parameters 29.07 and 29.08
302	PID out 2	Output of PID 2 controller. resolution 0.1 %, range is determined by parameters 29.27 and 29.28
303	PID out 3	Output of PID 3 controller. resolution 0.1 %, range is determined by parameters 29.47 and 29.48
304	PID out 4	Output of PID 4 controller. resolution 0.1 %, range is determined by parameters 29.67 and 29.68
305	Motopot 1	Ref.-unit of the motopotentiometer 1. Resolution 0.1 %, range 0...1000 = 0.0...100.0 %
306	Motopot 2	Ref.-unit of the motopotentiometer 2. Resolution 0.1 %, range 0...1000 = 0.0...100.0 %
307	Motopot 3	Ref.-unit of the motopotentiometer 3. Resolution 0.1 %, range 0...1000 = 0.0...100.0 %
308	Motopot 4	Ref.-unit of the motopotentiometer 4. Resolution 0.1 %, range 0...1000 = 0.0...100.0 %
309	Remote ref.	Value of the frequency ref.-unit which is transmitted through RS connection. Resolution 0.1 Hz. Sign determines direction of the electric motor rotation
310	Ref An. 0	Value of analog input 0 multiplied by parameter of scale 24.02 and added offset – par. 24.03
311	Ref An. 1	Value of analog input 1 multiplied by parameter of scale 24.12 and added offset – par. 24.13
312	Ref An. 2	Value of analog input 2 multiplied by parameter of scale 24.22 and added offset – par. 24.23
313	Ref An. 3	Value of analog input 3 multiplied by parameter of scale 24.32 and added offset – par. 24.33
314	Ref An. 4	Value of analog input 4 multiplied by parameter of scale 24.42 and added offset – par. 24.43
315	Comm chan. 1	Reference from active communication protocol on channel 1 (par 45.01)
316	Comm chan. 2	Reference from active communication protocol on channel 2 (par 46.01)
317	Comm chan. 3	Reference from active communication protocol on channel 3 (par 47.01)

PCH	PCH name	Function / value / note
320	Ref An. 11	Value of analog input 11 multiplied by parameter of scale 24.51 and added offset – par. 24.52
321	Ref An. 12	Value of analog input 12 multiplied by parameter of scale 24.56 and added offset – par. 24.57
322	Ref An. 21	Value of analog input 21 multiplied by parameter of scale 24.61 and added offset – par. 24.62
323	Ref An. 22	Value of analog input 22 multiplied by parameter of scale 24.66 and added offset – par. 24.67
324	Ref An. 31	Value of analog input 31 multiplied by parameter of scale 24.71 and added offset – par. 24.72
325	Ref An. 32	Value of analog input 32 multiplied by parameter of scale 24.76 and added offset – par. 24.77
326	Ref An. 41	Value of analog input 41 multiplied by parameter of scale 24.81 and added offset – par. 24.82
327	Ref An. 42	Value of analog input 42 multiplied by parameter of scale 24.86 and added offset – par. 24.87
328	Ref An. 51	Value of analog input 51 multiplied by parameter of scale 24.91 and added offset – par. 24.92
329	Ref An. 52	Value of analog input 52 multiplied by parameter of scale 24.96 and added offset – par. 24.97
330	100%	In all cases value 1000 corresponds to 100.0 % of referencing-units
340	Pid err 1	Value of present error of PID 1 controller (error = PID input – PID ref.-unit). Resolution 0.1 %
341	PID ref 1	Value of the PID 1 controller referencing-unit. Configured by par. 29.01
342	PID inp 1	Value of PID 1 controller input. Configured by par. 29.02
345	Pid err 2	Value of present error of PID 2 controller (error = PID input – PID ref.-unit). Resolution 0.1 %
346	PID ref 2	Value of the PID 2 controller referencing-unit. Configured by par. 29.21
347	PID inp 2	Value of PID 2 controller input. Configured by par. 29.22
350	PID err 3	Value of present error of PID 3 controller (error = PID input – PID ref.-unit). Resolution 0.1 %
351	PID ref 3	Value of the PID 3 controller referencing-unit. Configured by par. 29.41
352	PID inp 3	Value of PID 3 controller input. Configured by par. 29.42
355	PID err 4	Value of present error of PID 4 controller (error = PID input – PID ref.-unit). Resolution 0.1 %
356	PID ref 4	Value of the PID 4 controller referencing-unit. Configured by par. 29.61
357	PID inp 4	Value of PID 4 controller input. Configured by par. 29.62
360		<i>Service parameter</i>
361		<i>Service parameter</i>
362		<i>Service parameter</i>
370	Torque ref u	Value of the torque referencing-unit. Copy of PCH determined by parameters 20.12, 20.22, 20.32, 20.42. Resolution 0.1 %, range 0.0...100.0 %.
380	Refer. A1	Value of ref.-unit A1 chosen by parameter 20.10. Resolution 0.1 Hz, value with sign.
381	Refer. A2	Value of ref.-unit A2 chosen by parameter 20.20. Resolution 0.1 Hz, value with sign.
382	Refer. B1	Value of ref.-unit B1 chosen by parameter 20.30. Resolution 0.1 Hz, value with sign.
383	Refer. B2	Value of ref.-unit B2 chosen by parameter 20.20. Resolution 0.1 Hz, value with sign.
385	Refer. unit	Output of control unit – the final value of the referencing unit, value with a sign determining the direction of rotation (plus = to the right, minus = to the left). Resolution 0.1 Hz.
390	F. const 1	Constant frequency number 1, Copy of parameter 23.06

PCH	PCH name	Function / value / note
391	F. const 2	Constant frequency number 2, Copy of parameter 23.07
392	F. const 3	Constant frequency number 3, Copy of parameter 23.08
393	F. const 4	Constant frequency number 4, Copy of parameter 23.09
394	F. const 5	Constant frequency number 5, Copy of parameter 23.10
395	F. const 6	Constant frequency number 6, Copy of parameter 23.11
396	F. const 7	Constant frequency number 7, Copy of parameter 23.12
397	F. const 8	Constant frequency number 8, Copy of parameter 23.13
398	F. const 9	Constant frequency number 9, Copy of parameter 23.14
399	F. const 10	Constant frequency number 10, Copy of parameter 23.15
400	F. const 11	Constant frequency number 11, Copy of parameter 23.16
401	F. const 12	Constant frequency number 12, Copy of parameter 23.17
402	F. const 13	Constant frequency number 13, Copy of parameter 23.18
403	F. const 14	Constant frequency number 14, Copy of parameter 23.19
404	F. const 15	Constant frequency number 15, Copy of parameter 23.20
410	Freq last	Average frequency
411		<i>Service parameter</i>
412		<i>Service parameter</i>
420	Ref. user 1	Value of the user referencing-unit number 1
421	Ref. user 2	Value of the user referencing-unit number 2
422	Ref. user 3	Value of the user referencing-unit number 3
423	Ref. user 4	Value of the user referencing-unit number 4
424	Ref. user 5	Value of the user referencing-unit number 5
425	Ref. user 6	Value of the user referencing-unit number 6
426	Ref. user 7	Value of the user referencing-unit number 7
427	Ref. user 8	Value of the user referencing-unit number 8
428	Ref. user 9	Value of the user referencing-unit number 9
429	Ref. user 10	Value of the user referencing-unit number 10
430	Ref. A1 %	Value corresponds to PCH.380 (referencing-unit A1) converted to relative value (compared to rated motor frequency). Value without a sign, resolution 0.1 %.
431	Ref. A2%	Value corresponds to PCH.381 (referencing-unit A2) converted to relative value (compared to rated motor frequency). Value without a sign, resolution 0.1 %.
432	Ref. B1 %	Value corresponds to PCH.382 (referencing-unit B1) converted to relative value (compared to rated motor frequency). Value without a sign, resolution 0.1 %.
433	Ref. B2 %	Value corresponds to PCH.383 (referencing-unit B2) converted to relative value (compared to rated motor frequency). Value without a sign, resolution 0.1 %.
434	Freq nom %	Value corresponds to PCH.384 (referencing-unit) converted to relative value (compared to rated motor frequency). Value without a sign, resolution 0.1 %.
435		<i>Service parameter</i>
436		<i>Service parameter</i>
440	Process n	Speed of the process. Value of this PCH is a result of current rotation speed of the motor and scale factor determined with parameter 42.01. It serves for converting rotation speed to output value (e.g. m/s).
460		<i>Service parameter</i>
461		<i>Service parameter</i>
462		<i>Service parameter</i>

PCH	PCH name	Function / value / note
500	Inactive	Value always = L (logical 0)
501	Start local	H = Local Control (control panel) permits START Active when 000 Keyboard is chosen as Start/Stop for active Control place (A1/A2/B1/B2)
502	Start remote	H = Remote Control (digital inputs) permits START Active when 002 Remote 1 .. Remote 005 is chosen as Start/Stop for active Control place (A1/A2/B1/B2) <i>Note: This PCH do not determine rotation direction and only allows to start from digital inputs (remote 1..4) for active Control place (A1/A2/B1/B2)</i>
503	Start comm	H = Control through the connection RS allows START. Active when 001 Comm is chosen as Start/Stop for active Control place (A1/A2/B1/B2)
504	Keyboard dir	Direction of operation with Local Control. 0 = determined with sign of referencing-unit, H = opposite (depends on pressing the key "Left" or "Right" on the control panel).
505	Digital dir	Direction of operation with Remote Control. L = determined with sign of referencing-unit, H = opposite (depends on state of digital inputs and mode of Remote Start 002 Remote 1 .. 005 Remote 4).
506	Refer dir	Ref.-unit sign (L = positive ref.-unit, H = negative ref.-unit)
507	Under fstop	H = the converter is blocked because frequency referencing-unit is lower then STOP frequency determined by par. 21.10. This function will be switched on only in case of par. 21.11 = 001 Stop
508	Start allow	L = general lack of permission to work, H = permission to work (yellow LED on Control Panel is lighted up)
509	Rewers	Operating direction at currently chosen control. L = is determined with a sign of referencing-unit, H = opposite. Equal to PCH.505 for remote control, PCH.504 for local control, L for RS control.
510	Control A/B	Active when Control B is chosen
511	Control 1/2	Active when Control 2 is chosen
512	Comm allowed	L = general absence of permission to control the converter with RS, H = permission to control the converter with RS. Value of PCH is a copy of PCH which is set by parameter/pointer 40.07. If control through RS is selected (20.11, 20.21 or 20.31, 20.41) and PCH.512 = L, then the referencing-unit (value - PCH.385) and also PCH.508 and PCH.509 are set on value zero. If control is chosen by par. 20.11, 20.21 or 20.31, 20.41 and it differs from RS and PCH.512 = H, in this case it is possible to force externally control through RS. Active when communication is allowed - par. 40.07 Enable RS = 531 Allowed.
513	F const	H when referencing-unit of constant frequency is switched on. Depends from PCH, defined in the parameters 23.01 - 23.04.
514	Run	H when there is a voltage supplied to the electric motor
515	Ready	H when device is ready to work (no fault occurred)
516	Fault	H when a fault has occurred
517	Not fault	H when no fault occurred
518	Alarm	H when alarm is active
519	Alarm / fault	H when fault or alarm occurred
520	Blockade	Frequency converter is blocked (can't start), inverse of PCH 508 state
521	Freq lvl 1	H = The frequency level 1 defined in parameter 27.01 is exceeded
522	Freq lvl 2	H = The frequency level 2 defined in parameter 27.02 is exceeded
523	Freq reached	H when the electric motor reached the referenced frequency
524	Temp lvl 1	H = The temperature of the frequency converter heatsink has exceeded a threshold defined by parameter 27.04. Par. 27.03 specifies the hysteresis width
525	Temp lvl 2	H = The temperature of the frequency converter heatsink has exceeded a threshold defined by parameter 27.06. Par. 27.05 specifies the hysteresis width

PCH	PCH name	Function / value / note																																																						
526	Curr limit	H = The electric drive is in a mode of the output current limitation																																																						
527	Brake	H = mechanical brake released																																																						
528	PT100 lvl 1	H = The temperature of the Pt100 sensor has exceeded a threshold defined by parameter 27.11. Par. 27.10 specifies the hysteresis width																																																						
529	PT100 lvl 2	H = The temperature of the Pt100 sensor has exceeded a threshold defined by parameter 27.13. Par. 27.12 specifies the hysteresis width																																																						
530	NO/Disabled	Value always = L (logical 0)																																																						
531	YES/Enabled	Value always = H (logical 1)																																																						
532	PID1 sleep	H= PID1 is in sleep state																																																						
533	PID2 sleep	H= PID2 is in sleep state																																																						
534	PID3 sleep	H= PID3 is in sleep state																																																						
535	PID4 sleep	H= PID4 is in sleep state																																																						
536	Outlet 1	The PCH is switched on earlier to be able to switch on the output contactors. The output power circuit transistors are triggered with the delay specified in par. 21.17.																																																						
537		<i>Service parameter</i>																																																						
538	ACR run	H when ACR is running																																																						
539	ACR ready	H when ACR is ready																																																						
540	ACR fault	H when ACR has fault																																																						
541	ACR/VSD run	H when VSD and ACR is running																																																						
542	ACR grid ok	<i>Service parameter</i>																																																						
545	On limit I	The frequency converter is operating in the current limit																																																						
546	On limit M	The frequency converter is operating in the moment limit																																																						
547	On limit P	The frequency converter is operating in the power limit																																																						
570 ... 599	Constant 1 ... Constant 30	Constant number 1..30. Can be used as a factor in calculations made with help of Universal Block. It is a copy of parameters 75.01..75.30																																																						
600	VSD fault status	<p>The 16 most significant failures were encoded in a 16 bits register: 0 = no failure, 1 = active failure. Meaning of individual bits:</p> <table border="1"> <thead> <tr> <th>Bit nr</th> <th>Failure nr</th> <th>Bit nr</th> <th>Failure nr</th> <th>Bit nr</th> <th>Failure nr</th> </tr> </thead> <tbody> <tr> <td>0</td> <td>240, 241</td> <td>6</td> <td>320 LOW DC (VSD, ACR)</td> <td>12</td> <td>285</td> </tr> <tr> <td>1</td> <td>244</td> <td>7</td> <td>reserved</td> <td>13</td> <td>277, 278</td> </tr> <tr> <td>2</td> <td>250</td> <td>8</td> <td>268</td> <td>14</td> <td>other hardware</td> </tr> <tr> <td>3</td> <td>220, 221, 222, 223</td> <td>9</td> <td>260</td> <td>15</td> <td>other than all above</td> </tr> <tr> <td>4</td> <td>211, 212, 213</td> <td>10</td> <td>265</td> <td>-</td> <td>-</td> </tr> <tr> <td>5</td> <td>reserved</td> <td>11</td> <td>270</td> <td>-</td> <td>-</td> </tr> </tbody> </table> <p>Example: The value of PCH 600 = 0001 0000 0100 0010 means:</p> <table style="margin-left: 100px;"> <tr> <td></td> <td style="text-align: center;">↑</td> <td style="text-align: center;">↑</td> <td style="text-align: center;">↑</td> </tr> <tr> <td>Bit nr:</td> <td style="text-align: center;">12</td> <td style="text-align: center;">6</td> <td style="text-align: center;">1</td> </tr> <tr> <td>Failure nr:</td> <td style="text-align: center;">285</td> <td style="text-align: center;">320</td> <td style="text-align: center;">244</td> </tr> </table>	Bit nr	Failure nr	Bit nr	Failure nr	Bit nr	Failure nr	0	240, 241	6	320 LOW DC (VSD, ACR)	12	285	1	244	7	reserved	13	277, 278	2	250	8	268	14	other hardware	3	220, 221, 222, 223	9	260	15	other than all above	4	211, 212, 213	10	265	-	-	5	reserved	11	270	-	-		↑	↑	↑	Bit nr:	12	6	1	Failure nr:	285	320	244
Bit nr	Failure nr	Bit nr	Failure nr	Bit nr	Failure nr																																																			
0	240, 241	6	320 LOW DC (VSD, ACR)	12	285																																																			
1	244	7	reserved	13	277, 278																																																			
2	250	8	268	14	other hardware																																																			
3	220, 221, 222, 223	9	260	15	other than all above																																																			
4	211, 212, 213	10	265	-	-																																																			
5	reserved	11	270	-	-																																																			
	↑	↑	↑																																																					
Bit nr:	12	6	1																																																					
Failure nr:	285	320	244																																																					

12. Configuration Parameters

Read-only parameters

Group	Name	The description	Range	Res. ¹⁾
GROUP 00 – Electric motor				
00.00	N process	Speed of process. It depends on current rotation speed of the electric motor. It is possible to set up scale, measurement unit and number of decimal places for this parameter using parameters 42.01, 42.02 and 42.03	-32768..32767	1
00.01	Motor n	Current rotation speed of the electric motor in rotations per one minute [rpm]	-32768..32767	1
00.02	Ref. n	Value of the referenced rotation speed [rpm]	-32768..32767	1
00.03	f out	Current output frequency of the converter [Hz]	-327,68..327,67	0,01
00.04	f ref.	Referenced frequency [Hz]	-327,68..327,67	0,01
00.05	Mot torque	The moment of the drive compared to the nominal moment [%]	-3276,8..3276,7	0,1
00.06	Motor curr.	Average value of current in windings of the motor [A]	-3276,8..3276,7	0,1
00.07	Motor volt.	An output voltage AC of the converter [V] (voltage of the motor) – interfacial voltage	-32768..32767	1
00.08	Motor temp.	Higher of temperatures indicated by parameters 00.28 and 00.48 [%]	-3276,8..3276,7	0,1
00.09	Output power	Current output power of the converter at [kW]	-3276,8..3276,7	0,1
00.10	Power factor	Output power factor	-327,68..327,67	0,01
00.11	Energy	Value of energy which has been transferred to the electric motor from the time of first switching on the converter [kWh]	-32768..32767	1
00.12	Psi st.	Stator stream [Wb]	-32,768..32,767	0,001
00.13	Ia curr.	RMS current of a phase A of the motor [A]	-3276,8..3276,7	0,1
00.14	Ib curr.	RMS current of a phase B of the motor [A]	-3276,8..3276,7	0,1
00.15	Ic curr.	RMS current of a phase C of the motor [A]	-3276,8..3276,7	0,1
00.16	Encoder n	Encoder speed [rpm]	-32768..32767	1
00.28	Motor temp. 1	Calculated relative temperature of the motor 1 [%]	-3276,8..3276,7	0,1
00.33	Ia 1 curr.	RMS current of a phase A of the motor 1 [A]	-3276,8..3276,7	0,1
00.34	Ib 1 curr.	RMS current of a phase B of the motor 1 [A]	-3276,8..3276,7	0,1
00.35	Ic 1 curr.	RMS current of a phase C of the motor 1 [A]	-3276,8..3276,7	0,1
00.48	Motor temp. 2	Calculated relative temperature of the motor 2 [%]	-3276,8..3276,7	0,1
00.53	Ia 2 curr.	RMS current of a phase A of the motor 2 [A]	-3276,8..3276,7	0,1
00.54	Ib 2 curr.	RMS current of a phase B of the motor 2 [A]	-3276,8..3276,7	0,1
00.55	Ic 2 curr.	RMS current of a phase C of the motor 2 [A]	-3276,8..3276,7	0,1
GROUP 01 – Power circuit				
01.01	DC volt.	Voltage of the DC-link circuit of the converter [V]	-32768..32767	1
01.02	DC volt. 1	Voltage of the first half DC-link circuit of the converter [V] (only three-level inverters)	-32768..32767	1
01.03	DC volt. 2	Voltage of the second half DC-link circuit of the converter [V] (only three-level inverters)	-32768..32767	1
01.04	DC balance	Balance between DC volt 1 and DC volt 2 [%] (only three-level inverters)	-32768..32767	1
01.05	Grid volt.	Power line supply AC voltage [V] – estimated. The calculation is based on the DC-link voltage Udc measurement.	-32768..32767	1
01.06	Grid freq.	Line Voltage frequency [Hz]	-3276,8..3276,7	0,1
01.07	Active pow	Active power	-32768..32767	1
01.08	Reactive pow	Reactive power	-32768..32767	1
01.09	L1 curr.	RMS current of a phase L1 of the line [A]	-3276,8..3276,7	0,1
01.10	L2 curr.	RMS current of a phase L2 of the line [A]	-3276,8..3276,7	0,1
01.11	L3 curr.	RMS current of a phase L3 of the line [A]	-3276,8..3276,7	0,1
GROUP 02 – Temperature				
02.01	VSD temp 1	Temperature of the VSD's IGBT module 1 [°C]	-32768..32767	1
02.02	VSD temp 2	Temperature of the VSD's IGBT module 2 [°C]	-32768..32767	1
02.03	VSD temp 3	Temperature of the VSD's IGBT module 3 [°C]	-32768..32767	1
02.04	VSD inlet	Temperature of the VSD inlet (only in liquid cooled inverter) [°C]	-32768..32767	1
02.05	VSD outlet	Temperature of the VSD outlet (only in liquid cooled inverter) [°C]	-32768..32767	1
02.06	VSD temp 4	Temperature of the VSD's IGBT module 4 [°C]	-32768..32767	1
02.07	VSD temp 5	Temperature of the VSD's IGBT module 5 [°C]	-32768..32767	1
02.08	VSD temp 6	Temperature of the VSD's IGBT module 6 [°C]	-32768..32767	1
02.09	VSD temp 7	Temperature of the VSD's IGBT module 7 [°C]	-32768..32767	1
02.10	VSD temp 8	Temperature of the VSD's IGBT module 8 [°C]	-32768..32767	1
02.11	VSD temp 9	Temperature of the VSD's IGBT module 9 [°C]	-32768..32767	1

Group	Name	The description	Range	Res. ¹⁾
02.12	VSD temp 10	Temperature of the VSD's IGBT module 10 [°C]	-32768..32767	1
02.13	VSD temp 11	Temperature of the VSD's IGBT module 11 [°C]	-32768..32767	1
02.14	VSD temp 12	Temperature of the VSD's IGBT module 12 [°C]	-32768..32767	1
02.15	VSD temp max	The highest temperature of "VSD temp 1" .. "VSD temp 12" [°C]	-32768..32767	1
02.21	ACR temp 1	Temperature of the ACR's IGBT module 1 [°C]	-32768..32767	1
02.22	ACR temp 2	Temperature of the ACR's IGBT module 2 [°C]	-32768..32767	1
02.23	ACR temp 3	Temperature of the ACR's IGBT module 3 [°C]	-32768..32767	1
02.24	ACR inlet	Temperature of the ACR inlet (only in liquid cooled inverter) [°C]	-32768..32767	1
02.25	ACR outlet	Temperature of the ACR outlet (only in liquid cooled inverter) [°C]	-32768..32767	1
02.26	ACR temp 4	Temperature of the ACR's IGBT module 4 [°C]	-32768..32767	1
02.27	ACR temp 5	Temperature of the ACR's IGBT module 5 [°C]	-32768..32767	1
02.28	ACR temp 6	Temperature of the ACR's IGBT module 6 [°C]	-32768..32767	1
02.29	ACR temp 7	Temperature of the ACR's IGBT module 7 [°C]	-32768..32767	1
02.30	ACR temp 8	Temperature of the ACR's IGBT module 8 [°C]	-32768..32767	1
02.31	ACR temp 9	Temperature of the ACR's IGBT module 9 [°C]	-32768..32767	1
02.32	ACR temp 10	Temperature of the ACR's IGBT module 10 [°C]	-32768..32767	1
02.33	ACR temp 11	Temperature of the ACR's IGBT module 11 [°C]	-32768..32767	1
02.34	ACR temp 12	Temperature of the ACR's IGBT module 12 [°C]	-32768..32767	1
02.35	ACR temp max	The highest temperature of "ACR temp 1" .. "ACR temp 12" [°C]	-32768..32767	1
02.40	PT 100	Temperature of the PT100 sensor	-3276,8..3276,7	0,1
02.41	Ctrl temp 1	Service parameter	-32768..32767	1
02.42	Ctrl temp 2	Service parameter	-32768..32767	1
02.43	Ctrl temp 3	Service parameter	-32768..32767	1
02.44	Ctrl temp 4	Service parameter	-32768..32767	1
02.45	Ctrl temp 5	Service parameter	-32768..32767	1
02.46	Ctrl temp 6	Service parameter	-32768..32767	1
02.47	Ctrl temp 7	Service parameter	-32768..32767	1
02.48	Ctrl temp 8	Service parameter	-32768..32767	1
02.49	Ctrl temp 9	Service parameter	-32768..32767	1
02.50	Ctrl temp 10	Service parameter	-32768..32767	1
02.51	Ctrl temp 11	Service parameter	-32768..32767	1
02.52	Ctrl temp 12	Service parameter	-32768..32767	1
02.53	Ctrl temp 13	Service parameter	-32768..32767	1
02.54	Ctrl temp 14	Service parameter	-32768..32767	1
02.55	Ctrl temp 15	Service parameter	-32768..32767	1
GROUP 03 – Inputs / outputs				
03.01	DI state 1	Status of digital inputs 1..10	-32768..32767	1
03.02	DI state 2	Status of digital inputs 11..20	-32768..32767	1
03.03	DI state 3	Status of digital inputs 21..30	-32768..32767	1
03.04	DI state 4	Status of digital inputs 31..40	-32768..32767	1
03.05	DI state 5	Status of digital inputs 41..50	-32768..32767	1
03.06	DI state 6	Status of digital inputs 51..60	-32768..32767	1
03.11	DO state 1	Status of digital outputs 1..8	-32768..32767	1
03.12	DO state 2	Status of digital outputs 11..18	-32768..32767	1
03.13	DO state 3	Status of digital outputs 21..28	-32768..32767	1
03.14	DO state 4	Status of digital outputs 31..38	-32768..32767	1
03.15	DO state 5	Status of digital outputs 41..48	-32768..32767	1
03.16	DO state 6	Status of digital outputs 51..58	-32768..32767	1
03.21	In.A0	Value of an analog input 0	-327,68..327,67	0,01
03.22	In.A0 Sc	Value of an analog input 0 [%]	-3276,8..3276,7	0,1
03.23	In.A1	Value of an analog input 1	-3276,8..3276,7	0,01
03.24	In.A1 Sc	Value of an analog input 1 [%]	-3276,8..3276,7	0,1
03.25	In.A2	Value of an analog input 2	-3276,8..3276,7	0,01
03.26	In.A2 Sc	Value of an analog input 2 [%]	-3276,8..3276,7	0,1
03.27	In.A3	Value of an analog input 3	-3276,8..3276,7	0,01
03.28	In.A3 Sc	Value of an analog input 3 [%]	-3276,8..3276,7	0,1
03.29	In.A4	Value of an analog input 4	-3276,8..3276,7	0,01
03.30	In.A4 Sc	Value of an analog input 4 [%]	-3276,8..3276,7	0,1
03.31	In.A11	Value of an analog input 11	-3276,8..3276,7	0,1
03.32	In.A11 Sc	Value of an analog input 11 [%]	-3276,8..3276,7	0,1
03.33	In.A12	Value of an analog input 12	-3276,8..3276,7	0,1

Group	Name	The description	Range	Res. ¹⁾
03.34	In.A12 Sc	Value of an analog input 12 [%]	-3276,8..3276,7	0,1
03.35	In.A21	Value of an analog input 21	-3276,8..3276,7	0,1
03.36	In.A21 Sc	Value of an analog input 21 [%]	-3276,8..3276,7	0,1
03.37	In.A22	Value of an analog input 22	-3276,8..3276,7	0,1
03.38	In.A22 Sc	Value of an analog input 22 [%]	-3276,8..3276,7	0,1
03.39	In.A31	Value of an analog input 31	-3276,8..3276,7	0,1
03.40	In.A31 Sc	Value of an analog input 31 [%]	-3276,8..3276,7	0,1
03.41	In.A32	Value of an analog input 32	-3276,8..3276,7	0,1
03.42	In.A32 Sc	Value of an analog input 32 [%]	-3276,8..3276,7	0,1
03.43	In.A41	Value of an analog input 41	-3276,8..3276,7	0,1
03.44	In.A41 Sc	Value of an analog input 41 [%]	-3276,8..3276,7	0,1
03.45	In.A42	Value of an analog input 42	-3276,8..3276,7	0,1
03.46	In.A42 Sc	Value of an analog input 42 [%]	-3276,8..3276,7	0,1
03.47	In.A51	Value of an analog input 51	-3276,8..3276,7	0,1
03.48	In.A51 Sc	Value of an analog input 51 [%]	-3276,8..3276,7	0,1
03.49	In.A52	Value of an analog input 52	-3276,8..3276,7	0,1
03.50	In.A52 Sc	Value of an analog input 52 [%]	-3276,8..3276,7	0,1
03.51	Out A1	Value of an analog output 1	-3276,8..3276,7	0,1
03.52	Out A1 Sc	Value of an analog output 1 [%]	-3276,8..3276,7	0,1
03.53	Out A2	Value of an analog output 2	-3276,8..3276,7	0,1
03.54	Out A2 Sc	Value of an analog output 2 [%]	-3276,8..3276,7	0,1
03.55	Out A11	Value of an analog output 11	-3276,8..3276,7	0,1
03.56	Out A11 Sc	Value of an analog output 11 [%]	-3276,8..3276,7	0,1
03.57	Out A12	Value of an analog output 12	-3276,8..3276,7	0,1
03.58	Out A12 Sc	Value of an analog output 12 [%]	-3276,8..3276,7	0,1
03.59	Out A23	Value of an analog output 23	-3276,8..3276,7	0,1
03.60	Out A23 Sc	Value of an analog output 23 [%]	-3276,8..3276,7	0,1
03.61	Out A22	Value of an analog output 22	-3276,8..3276,7	0,1
03.62	Out A22 Sc	Value of an analog output 22 [%]	-3276,8..3276,7	0,1
03.63	Out A31	Value of an analog output 31	-3276,8..3276,7	0,1
03.64	Out A31 Sc	Value of an analog output 31 [%]	-3276,8..3276,7	0,1
03.65	Out A32	Value of an analog output 32	-3276,8..3276,7	0,1
03.66	Out A32 Sc	Value of an analog output 32 [%]	-3276,8..3276,7	0,1
03.67	Out A41	Value of an analog output 41	-3276,8..3276,7	0,1
03.68	Out A41 Sc	Value of an analog output 41 [%]	-3276,8..3276,7	0,1
03.69	Out A42	Value of an analog output 42	-3276,8..3276,7	0,1
03.70	Out A42 Sc	Value of an analog output 42 [%]	-3276,8..3276,7	0,1
03.71	Out A51	Value of an analog output 51	-3276,8..3276,7	0,1
03.72	Out A51 Sc	Value of an analog output 51 [%]	-3276,8..3276,7	0,1
03.73	Out A52	Value of an analog output 52	-3276,8..3276,7	0,1
03.74	Out A52 Sc	Value of an analog output 52 [%]	-3276,8..3276,7	0,1
GROUP 04 - References				
04.00	Ref. status	Service parameter	-32768..32767	1
04.01	Ref. chosen	Value corresponding to chosen Control place	-32768..32767	1
04.02	Ref. act. A1	Ref. value of Control place A1	-32768..32767	1
04.03	Ref. act. A2	Ref. value of Control place A2	-32768..32767	1
04.04	Ref. act. B1	Ref. value of Control place B1	-32768..32767	1
04.05	Ref. act. B2	Ref. value of Control place B2	-32768..32767	1
04.11	PID 1 ref	Value of current referencing-unit of the PID 1 controller [%]	-3276,8..3276,7	0,1
04.12	PID 1 inp.	Current input value of the PID 1 controller [%]	-3276,8..3276,7	0,1
04.13	PID 1 err.	Error of the PID 1 controller [%]	-3276,8..3276,7	0,1
04.14	PID 1 out.	Current output value of the PID 1 controller [%]	-3276,8..3276,7	0,1
04.21	PID 2 ref	Value of current referencing-unit of the PID 2 controller [%]	-3276,8..3276,7	0,1
04.22	PID 2 inp.	Current input value of the PID 2 controller [%]	-3276,8..3276,7	0,1
04.23	PID 2 err.	Error of the PID 2 controller [%]	-3276,8..3276,7	0,1
04.24	PID 2 out.	Current output value of the PID 2 controller [%]	-3276,8..3276,7	0,1
04.31	PID 3 ref	Value of current referencing-unit of the PID 3 controller [%]	-3276,8..3276,7	0,1
04.32	PID 3 inp.	Current input value of the PID 3 controller [%]	-3276,8..3276,7	0,1
04.33	PID 3 err.	Error of the PID 3 controller [%]	-3276,8..3276,7	0,1
04.34	PID 3 out.	Current output value of the PID 3 controller [%]	-3276,8..3276,7	0,1
04.41	PID 4 ref	Value of current referencing-unit of the PID 4 controller [%]	-3276,8..3276,7	0,1

Group	Name	The description	Range	Res. ¹⁾
04.42	PID 4 inp.	Current input value of the PID 4 controller [%]	-3276,8..3276,7	0,1
04.43	PID 4 err.	Error of the PID 4 controller [%]	-3276,8..3276,7	0,1
04.44	PID 4 out.	Current output value of the PID 4 controller [%]	-3276,8..3276,7	0,1
04.51	Ref user 1	User 1 reference	-32768..32767	1
04.52	Ref user 2	User 2 reference	-32768..32767	1
04.53	Ref user 3	User 3 reference	-32768..32767	1
04.54	Ref user 4	User 4 reference	-32768..32767	1
04.55	Ref user 5	User 5 reference	-32768..32767	1
04.56	Ref user 6	User 6 reference	-32768..32767	1
04.57	Ref user 7	User 7 reference	-32768..32767	1
04.58	Ref user 8	User 8 reference	-32768..32767	1
04.59	Ref user 9	User 9 reference	-32768..32767	1
04.60	Ref user 10	User 10 reference	-32768..32767	1
GROUP 05 - Status				
05.00	Act. motor	Status of active electric motor	-32768..32767	1
05.01	Run status	Service parameter	-32768..32767	1
05.02	Statusword	Service parameter	-32768..32767	1
05.03	Ref. place	Service parameter	-32768..32767	1
05.11	Encoder 1	Encoder speed [rpm]	-32768..32767	1
05.20	U. par 1	User parameter 1	-32768..32767	1
05.21	U. par 2	User parameter 2	-32768..32767	1
05.22	U. par 3	User parameter 3	-32768..32767	1
05.23	U. par 4	User parameter 4	-32768..32767	1
05.24	U. par 5	User parameter 5	-32768..32767	1
05.25	U. par 6	User parameter 6	-32768..32767	1
05.26	U. par 7	User parameter 7	-32768..32767	1
05.27	U. par 8	User parameter 8	-32768..32767	1
05.28	U. par 9	User parameter 9	-32768..32767	1
05.29	U. par 10	User parameter 10	-32768..32767	1
05.30	U. par 11	User parameter 11	-32768..32767	1
05.31	U. par 12	User parameter 12	-32768..32767	1
05.32	U. par 13	User parameter 13	-32768..32767	1
05.33	U. par 14	User parameter 14	-32768..32767	1
05.34	U. par 15	User parameter 15	-32768..32767	1
05.35	U. par 16	User parameter 16	-32768..32767	1
05.36	U. par 17	User parameter 17	-32768..32767	1
05.37	U. par 18	User parameter 18	-32768..32767	1
05.38	U. par 19	User parameter 19	-32768..32767	1
05.39	U. par 20	User parameter 20	-32768..32767	1
GROUP 06 - Advanced				
06.01	Pump state	State of operation the Control unit of Pumps Group	-32768..32767	1
06.02	Pump 1 time	Pump's 1 operating hours [h]	-32768..32767	1
06.03	Pump 2 time	Pump's 2 operating hours [h]	-32768..32767	1
06.04	Pump 3 time	Pump's 3 operating hours [h]	-32768..32767	1
06.05	Pump 4 time	Pump's 4 operating hours [h]	-32768..32767	1
06.06	Pump 5 time	Pump's 5 operating hours [h]	-32768..32767	1
06.07	Pump 6 time	Pump's 6 operating hours [h]	-32768..32767	1
06.10	Diameter	Service parameter	-32768..32767	1
GROUP 07 - Communication				
07.01	RS refer.	Service parameter	-3276,8..3276,7	0,1
07.02	RS CW	Service parameter	-32768..32767	1
07.03	RS SW	Service parameter	-32768..32767	1
07.11	Recv pack. 1	Number of received packets on channel 1	0..65535	1
07.12	Send pack. 1	Number of sent packets on channel 1	0..65535	1
07.13	Act. prot. 1	Active protocol on channel 1	0	1
07.21	Recv pack. 2	Number of received packets on channel 2	0..65535	1
07.22	Send pack. 2	Number of sent packets on channel 2	0..65535	1
07.23	Act. prot. 2	Active protocol on channel 2	0	1
07.31	Recv pack. 3	Number of received packets on channel 3	0..65535	1
07.32	Send pack. 3	Number of sent packets on channel 3	0..65535	1
07.33	Act. prot. 3	Active protocol on channel 3	0	1

Group	Name	The description	Range	Res. ¹⁾
07.40	Eth. IP 1	Ethernet IP address 1	0..255	1
07.41	Eth. IP 2	Ethernet IP address 2	0..255	1
07.42	Eth. IP 3	Ethernet IP address 3	0..255	1
07.43	Eth. IP 4	Ethernet IP address 4	0..255	1
07.44	Eth. MASK 1	Ethernet mask 1	0..255	1
07.45	Eth. MASK 2	Ethernet mask 2	0..255	1
07.46	Eth. MASK 3	Ethernet mask 3	0..255	1
07.47	Eth. MASK 4	Ethernet mask 4	0..255	1
07.48	Eth. GW 1	Ethernet gateway 1	0..255	1
07.49	Eth. GW 2	Ethernet gateway 2	0..255	1
07.50	Eth. GW 3	Ethernet gateway 3	0..255	1
07.51	Eth. GW 4	Ethernet gateway 4	0..255	1
07.52	Eth. state	Status of Ethernet connection	0..1000	1
GROUP 09 - Special info				
09.01	Run time	Quantity of hours of converter's operation [h]	-32768..32767	1
09.02	ServiceCode 1	Permanent service code	0..65535	1
09.03	ServiceCode 2	Temporary service code - 24h	0..65535	1
09.10	Ctrl version	Version of a main control program	-327.68..327.67	0,01
09.11	Ctrl revision	Revision of a main control program	-32768..32767	1
09.12	VSD version	Version of a VSD control program	-327.68..327.67	0,01
09.13	VSD revision	Revision of a VSD control program	-32768..32767	1
09.14	ACR version	Version of an AcR control program	-327,68..327,67	0,01
09.15	ACR revision	Revision of an AcR control program	-32768..32767	1
09.20	Timer 1 hour	Number of hours elapsed in Timer 1	-32768..32767	1
09.21	Timer 1 minute	Number of minutes elapsed in Timer 1	-32768..32767	1
09.22	Timer 2 hour	Number of hours elapsed in Timer 2	-32768..32767	1
09.23	Timer 2 minute	Number of minutes elapsed in Timer 2	-32768..32767	1
09.24	Timer 3 hour	Number of hours elapsed in Timer 3	-32768..32767	1
09.25	Timer 3 minute	Number of minutes elapsed in Timer 3	-32768..32767	1
09.26	Timer 4 hour	Number of hours elapsed in Timer 4	-32768..32767	1
09.27	Timer 4 minute	Number of minutes elapsed in Timer 4	-32768..32767	1
09.28	Timer 5 hour	Number of hours elapsed in Timer 5	-32768..32767	1
09.29	Timer 5 minute	Number of minutes elapsed in Timer 5	-32768..32767	1

¹⁾ Parameter resolution

Read-write parameters

Parameter / Name	Function	Available options / measurement unit	Factory setting	Change during operation
GROUP 10 – Nominal par. motor.				
10.00 Motor count	Number of connected motors to inverter	1, 2	1	No
10.01 Nom. power	Nominal motor power	0.0 .. 2 x [Nominal power of the freq. converter] kW	Nominal power of the frequency converter	No
10.02 Nom. speed	Nominal motor speed	0 .. 30000 rpm	1450 rpm	No
10.03 Nom. current	Nominal motor current	0.0 .. 2 x [Nominal current of the freq. converter] A	Nominal current of the frequency converter	No
10.04 Nom. voltage	Nominal motor voltage	0 .. 1200 V	Nominal voltage of the frequency converter	No
10.05 Nom. freq.	Nominal motor frequency	0.0 .. 550.0 Hz	50.0 Hz	No
10.06 Nom. PF	Nominal $\cos \varphi_n$ of the motor	0.00 ... 0.99	0.80	No
10.11 Rs	Resistance stator windings	0.00 .. 650.00 Ohm	0.00 Ohm	No
10.12 Rr	Resistance of rotor windings	0.00 ... 650.00 Ohm	0.00 Ohm	No
10.13 Lm	Main inductance Lm	0 .. 65000 mH	0 mH	No
10.14 Ls	Stator inductance Ls	0 .. 65000 mH	0 mH	No
10.15 Lr	Rotor inductance Lr	0 .. 65000 mH	0 mH	No
10.16 L addit.	Additional inductance in stator's circuit (inductance of wires)	0 .. 65000 mH <i>Service parameter</i>	0 mH	
10.18 Save motor	Saving present motors parameters	Memory buffers designed for writing: 001 Motor 1 002 Motor 2 003 Motor 3 004 Motor 4	001 Motor 1	No
10.19 Read motor	Restoring previously saved motors parameters.	Memory buffers designed for reading previously saved motor parameters: 001 Motor 1 002 Motor 2 003 Motor 3 004 Motor 4	001 Motor 1	No
10.20 ID run	Identification of motor's equivalent circuit parameters	000 --- - without any identification 001 Dont run - identification performed on stopped motor 002 Run fn/2 - identification performed at 25 Hz 003 Run fn - identification performed at 50 Hz	---	No
GROUP 11 – Motor configuration				
11.02 Oper. mode	Device operating mode	000 U/f lin. – operation in scalar mode (linear characteristic) 001 U/f sq. – as above (square-law characteristic) 002 Vector s. less – vector mode without sensors 003 Vector sensor – vector mode with encoder	U/f lin.	No
11.03 Switch. freq.	Switching frequency of the converter's power transistors	0.5 ... 16.0 kHz Note: The setting range and factory setting depends on the converter's nominal power	2.5 kHz	No
11.20 Stop mode	Stopping by coast or according to characteristic	000 Ramp – deceleration to 0 Hz at first, then shutting down 001 Coast – stopping by running out after STOP command (voltage taken off immediately) 002 BSC - Backspin mode	000 Ramp	Yes
11.25 Rotation dir.	Direction of motor rotation	000 Reverse – bidirectional 001 Right – only right rotation 002 Left – only left rotation	000 Reverse	Yes

Parameter / Name	Function	Available options / measurement unit	Factory setting	Change during operation
11.30 Flyin start	Running the frequency converter when motor is spinning	0 – function disabled 1 – search in one direction, searched frequencies: from Fref or Fmax 2 – search in both directions, searched frequencies: from Fref or Fmax 3 – search in one direction, searched frequencies: from Fmax 4 – search in both directions, searched frequencies: from Fmax	0	Yes
11.40 Reg hi. UDC	Protection against exceeding the high DC voltage	000 No 001 Yes <i>Service parameter</i>	000 No	Yes
11.41 Reg lo. UDC		<i>Service parameter</i>	NO	Yes
11.43 Phase loss	Phase loss	000 No 001 Yes	000 No	No
11.50 DC breaking voltage	Voltage of DC braking	0.0 .. 40.0% motor's Un	0.5%	Yes
11.51 DC breaking time	Breaking time	0.0 .. 320.0s	2.0s	Yes
11.52 DC breaking enable	Enable DC braking	000 – Disabled 531 – Enabled	000 - Disabled	Yes
11.53 DC breaking current	Current of DC braking	0.0 .. 120.0% of motor's current	50.0%	Yes
11.60 Br rel. delay	Delay of releasing external brake	0.0 .. 12.0 s	0.0 s	Yes
11.61 Br. close n	Speed above which brake is being closed	0 .. 10000 rpm	0 rpm	Yes
11.62 Br. close t	Device operation time (giving torque) after which command to close the brake is send	0.0 .. 12.0 s	0.0 s	Yes
11.63 Br. curr. lvl.	Minimal motor current for releasing brake	0.0 .. 100.0% of motor's current	40.0%	Yes
11.68 Min t Stop	Minimal time of stopping	0.00 .. 10.00 s	0.10 s	Yes
GROUP 12 – Encoder				
12.01 Enc. typ	Encoder type	<i>Service parameter</i>		No
12.02 Enc .i./o.	Amount of pulses per encoder rotation	1 ... 9999 DEPENDS ON ENCODER TYPE!	1024	No
12.03 Enc. revers	Reverse direction of rotations of encoder	000 No - disabled 001 Yes - enabled It depends on a way of encoder installation on the shaft of the drive. For correct operation of converter in „ 003 Vector sensor “ mode, detected direction of rotation must be the same as actual direction.	000 NO	No
GROUP 13 – Dynamic & limit				
13.01 Accel. 1	Acceleration DYNAMICS 1	0.0 ... 600.0 s	5.0	Yes
13.02 Decel. 1	Delay DYNAMICS 1	0.0 ... 600.0 s	5.0	Yes
13.10 Accel. 2	Acceleration DYNAMICS 2	0.0 ... 600.0 s	20 s	Yes
13.11 Decel. 2	Delay DYNAMICS 2	0.0 ... 600.0 s	20 s	Yes
13.20 Stop Delay	Set stopping time of the motor	0.0 ... 600.0 s	15.0 s	Yes
13.30 S curve	S curve	0 ... 300 %	0 %	Yes
13.35 Dyn. choice	Enabling DYNAMICS 1 or DYNAMICS 2	000 Disabled – Dynamics 1 active (accel. and delay 1) 001 DI1 .. 010 DI10 – switching on Dynamics 2 by means of digital input DI1...DI10 531 Enabled – Dynamics 2 active (accel. and delay 2)	000 Disabled	Yes
13.40 F max.	Maximum output frequency	0.0 .. 600.0 Hz Exceeding this value results in failure no 270 F>max. NOTE: see also par. 21.02	55.0 Hz	Yes
13.41 I limit M	Current restriction at motor operation	0.0 .. 200.0 % motor In	150.0 %	Yes
13.42 I limit G	Current restriction at generator operation	0.0 .. 200.0 % motor In	150.0 %	Yes

Parameter / Name	Function	Available options / measurement unit	Factory setting	Change during operation
13.43 M limit M	Torque restriction at motor operation	0.0 .. 200.0 % motor Mn	150.0 %	Yes
13.44 M limit G	Torque restriction at generator operation	0.0 .. 200.0 % motor M	150.0 %	Yes
13.50 Limit Mocy S	Limit of active power in motor operating mode (power consumed by the electric motor)	0.0 .. 150.0 % frequency converter Pn	150.0 %	Yes
13.51 Limit Mocy P	Limit of active power in generator operating mode (power produced by the electric motor)	0.0 .. 150.0 % frequency converter Pn	20.0 %	Yes
Group 14 Elimin. freq.				
14.1 f elim1 min	Minimum frequency of frequency elimination range number 1	0.0 .. 550.0 Hz	0.0 Hz	Yes
14.2 f elim1 max	Maximum frequency of frequency elimination range number 1	0.0 .. 550.0 Hz	0.0 Hz	Yes
14.3 f elim2 min	Minimum frequency of frequency elimination range number 2	0.0 .. 550.0 Hz	0.0 Hz	Yes
14.4 f elim2 max	Maximum frequency of frequency elimination range number 2	0.0 .. 550.0 Hz	0.0 Hz	Yes
14.5 f elim3 min	Minimum frequency of frequency elimination range number 3	0.0 .. 550.0 Hz	0.0 Hz	Yes
14.6 f elim3 max	Maximum frequency of frequency elimination range number 3	0.0 .. 550.0 Hz	0.0 Hz	Yes
Group 15 – Scalar operating mode				
15.01 U0	Voltage for output frequency F0 (par. 15.02)	0.0 .. 40.0 % motor Un	2.0 %	Yes
15.02 F0	F0 frequency	0.0 .. 20.0 %	0.0 %	Yes
15.03 U1	Voltage for output frequency F1 (par 15.04)	0.0 .. 100.0 %	50.0 %	Yes
15.04 f1	F1 frequency	0.0 .. 100.0 %	50.0 %	Yes
15.10 dU at In	Compensation of a voltage drop from output current	0.0 .. 40.0 % Un	0.0 %	Yes
15.15 Slip comp.	Slip compensation	000 No 001 Yes	000 No	Yes
15.20 f Start	Start Minimal output frequency for U/f operation modes	0.0 .. 40.0 Hz	0.0 Hz	Yes
Group 16 – Vector operating mode				
16.00 Sel. Torque	Direct torque set	240 Speed reg – normal operation xxx PCH – direct torque from other source (any PCH)	240 Speed reg	Yes
16.01 Amp. reg.n	Speed regulator gain	Service parameter for Vector modes	2.0	Yes
16.02 Ki of reg.n	Integration time of speed regulator	Service parameter for Vector modes	2.00 s	Yes
16.03 Amp. reg.M	Torque regulator gain	Service parameter for Vector modes	0.60	Yes
16.04 Ki reg.M	Integration time of Torque regulator	Service parameter for Vector modes	1.00	Yes
16.05 Amp. reg.S	Motor stream regulator gain	Service parameter for Vector modes	650	Yes
16.06 Ki reg.S	Integration time of motor stream regulator	Service parameter for Vector modes	0.003	Yes
16.10 Ttemp RS Factor	Temperature coefficient of stator resistance	0.0 .. 100.0 %	0.0%	Yes
16.11 Ttemp RR Factor	Temperature coefficient of rotor resistance	0.0 .. 100.0 %	0.0%	Yes
Group 17 – Backspin control (BSC)				
17.01 Enable BSC	On/off of the backspin control	000 No 001 Yes	000 No	Yes
17.02 BSC acc.	Backspin acceleration	0.0 .. 320.0 s	20 s	

Parameter / Name	Function	Available options / measurement unit	Factory setting	Change during operation
17.03 BSC freq min	Minimal output frequency of backspin controller	0.5 .. 20.0 Hz	2.0 Hz	Yes
17.04 BSC freq max	Maximum output frequency of backspin controller	1.0 .. 50.0 Hz	10.0 Hz	Yes
17.05 BSC Kp speed	Kp of BSC speed controller	1.0 .. 3200.0 %	100.0%	Yes
17.06 BSC Ti speed	Ti of BSC speed controller	1.0 .. 3200.0 %	100.0%	Yes
17.07 BSC Kp Torque	Kp of BSC torque controller	1.0 .. 3200.0 %	100.0%	Yes
17.08 BSC Ti Torque	Ti of BSC torque controller	1.0 .. 3200.0 %	100.0%	Yes
17.09 BSC Min ref U	Udc min BSC	0 .. 900 V	610 V	Yes
17.10 BSC Max ref U	Udc max BSC	0 .. 900 V	710 V	Yes
17.11 BSC stop torque	Service parameter	-10.0 .. 30.0 %	0.0%	Yes
17.12 BSC torque stop	Backspin control torque stop	-20.0 .. 30.0 % The value of the torque at which the drive will stop. <i>Active when par. 11.20=002 BSC.</i>	10%	Yes
17.13 BSC max time	Service parameter			
Group 18 - NC RfG grid parameters				
18.01 Nominal grid voltage	Line to line grid voltage	230-690V <i>Read only. The value is set in the parameter 19.02</i>	Nominal voltage	Yes
18.02 Nominal grid frequency	Nominal grid frequency	50Hz, 60Hz <i>Read only. The value is set in the parameter 19.03</i>	Nominal frequency	Yes
18.03 Nominal Power	Nominal Power	0...1.2Pn	Pn	Yes
18.10 UnderVoltage St1	Undervoltage stage 1	0.2..1.00	0.85	Yes
18.11 UnderVoltage St1 Time	Time of undervoltage stage 1	0.1..100.0 s	1.2 s	Yes
18.12 UnderVoltage St2	Undervoltage stage 2	0.20..1.00	0.4	Yes
18.13 UnderVoltage St2 Time	Time of undervoltage stage 2	0.10..5.00 s (rozd.: 0.05s)	0.20 s	Yes
18.14 OverVoltageSt1	Overvoltage stage 1 (immediate)	1.00..1.20	1.15	Yes
18.15 OverVoltage St1Time	Time of overvoltage stage 1	0.1..100.0 s	0.1 s	Yes
18.16 OverVoltageSt2	Overvoltage stage 2 (immediate)	1.00..1.30	1.15	Yes
18.17 OverVoltageSt2 Time	Time of overvoltage stage 2	0.10..5.00 s (rozd.: 0.05s)	0.10 s	Yes
18.18 OverVoltage10min	10 minutes overvoltage protection threshold (delayed)	1.00..1.15	1.10	Yes
18.20 UnderFreqSt1	Underfrequency stage 1	47.0..50.0 Hz dla fn=50 Hz (par. 18.02) 57.0..60.0 Hz dla fn=60 Hz (par. 18.02)	47.5 Hz 57,5 Hz	Yes
18.21 UnderFreqTimeSt1	Time of underfrequency stage 1	0.1..100.0 s	0.1 s	Yes
18.22 UnderFreqSt2	Underfrequency stage 2	47.0..50.0 Hz dla fn=50 Hz (par. 18.02) 57.0..60.0 Hz dla fn=60 Hz (par. 18.02)	47.5 Hz 57,5 Hz	Yes
18.23 UnderFreqTimeSt2	Time of underfrequency stage 2	0.10..5.00 s (rozd.: 0.05s)	0.10 s	Yes
18.24 OverFreq St1	Overfrequency stage 1	50.0..52.0 Hz dla fn=50 Hz (par. 18.02) 60.0..62.0 Hz dla fn=60 Hz (par. 18.02)	52.0 Hz 62.0 Hz	Yes
18.25 OverFreqTimeSt1	Time of overfrequency stage 1	0.1..100.0 s	0.1 s	Yes
18.26 OverFreq St2	Overfrequency stage 2	50.0..52.0 Hz dla fn=50 Hz (par. 18.02) 60.0..62.0 Hz dla fn=60 Hz (par. 18.02)	52.0 Hz 62.0 Hz	Yes
18.27 OverFreqTimeSt2	Time of overfrequency stage 2	0.10..5.00 s (rozd.: 0.05s)	0.10 s	Yes
18.28 Rocof Ramp	Rate of Change of Frequency (RoCoF) protection value	0.0..3.0 Hz/min	2.5 Hz/min	Yes
18.29 Rocof Time	Time constant of RoCoF protection	0.10..1.00 s (rozd.:0.05s)	0.10 s	Yes
LFSM-U – optional				

Parameter / Name	Function	Available options / measurement unit	Factory setting	Change during operation
18.30 Under Treshold freq f1	Grid frequency threshold below which the inverter's output power starts to increase	46.0..49.8 Hz dla fn=50 Hz (par. 18.02) 56.0..59.8 Hz dla fn=60 Hz (par. 18.02) <i>Setting the value to 46.0 disables this feature</i>	49.8 Hz 59.8 Hz	Yes
18.31 UnderFreqDroop	Percentage increase of the inverter output power limit with the decrease of the grid frequency below the activation threshold	0.1..100.0 s	5%	Yes
18.32 UnderFreq PowerRef	Selection of the reference power when the frequency threshold is exceeded	0 – Pmax 1 – Pm where: Pm - power at the time of exceeding Pmax - nominal power of the inverter	Pmax	Yes
18.33 UnderFreq IntentDelay	LFSM-U activation delay	0.0..2.0 s (resolution: 0.1 s)	0	Yes
LFSM-O				
18.34 OverFreq Treshold freq f1	Grid frequency threshold above which the inverter's output power begins to be limited	50.2..52.0 Hz dla fn=50 Hz (par. 18.02) 60.2..62.0 Hz dla fn=60 Hz (par. 18.02) <i>Setting the value to 52.0 disables this feature</i>	50.2 Hz 60.2 Hz	Yes
18.35 OverFreqDroop	The percentage decrease of the inverter output power limit with the increase of the grid frequency above the activation threshold	2..12%	5%	Yes
18.36 Over Freq PowerRef	Selection of the reference power when the frequency threshold is exceeded	0 – Pmax 1 – Pm where: Pm - power at the time of exceeding Pmax - nominal power of the inverter	Pmax	Yes
18.37 OverFreq IntentDelay	LFSM-O activation delay	0.0..2.0 s	0 s	Yes
18.38 Fstop	LFSM-O latched limit deactivation threshold	50.0..52.0 Hz dla fn=50 Hz (par. 18.02) 60.0..62.0 Hz dla fn=60 Hz (par. 18.02) When \geq par.18.34 (OverFreq Treshold freq f1) then deactivates the latching of the limit	52.0 Hz 62.0 Hz	Yes
18.39 UF-Deactivation Time Fstop	Delay of limit reset	0.0..2.0 s	0 s	Yes
Control – optional				
18.40 Control Mode	Reactive power generation control mode	0 – Qset 1 – $\cos \varphi$ set 2 – Q(U) 3 – $\cos\varphi(P)$ 4 – remote	0	Yes
18.41 Q set	The setting of the reactive power as a percentage of the active power of the device for parameter 18.40 = 0	-110..+110 %	0	Yes
18.45 Cosfi set	$\cos \varphi$ setting for par.18.40 = 1	-0.8..0.8	0	Yes
18.50 uV2	QuV1 setting for par.18.40=2	0.80..1.00	0.92	Yes
18.51 QuV2	Q for uV1 par.18.40=2	-48..48 %	48%	Yes
18.52 uV1	Voltage for QuV1 par.18.40=2	0.90..1.00	0.94	Yes
18.53 QuV1	Q for uV1 par.18.40=2	-48..48 %	0	Yes
18.54 oV1	Voltage for QoV1 par.18.40=2	1.00..1.15	1.06	Yes
18.55 QoV1	Q for oV1 par.18.40=2	-48..48 %	0	Yes
18.56 oV2	Voltage for QoV2 par.18.40=2	1.00..1.15	1.08	Yes
18.57 QoV2	Q for oV2 par.18.40=2	-48..48 %	-48%	Yes

Parameter / Name	Function	Available options / measurement unit	Factory setting	Change during operation
18.58 Time filter	Time constant of the control filter according to the Q (U) characteristic par.18.40=2	3..60 s	10 s	Yes
18.59 Lock in power	Power level for Q (U) regulation activation par.18.40=2	0..20 %	0	Yes
18.60 Lock out power	Power level for switching off Q (U) regulation par.18.40=2	0..20 %	0	Yes
18.62 P1	Power value P1 of the cosφ (P) characteristic par.18.40=3	0.01..1.00	0.20	Yes
18.63 cosfi (P1)	Cosφ setting for the power P1 of the cosφ (P) characteristic par.18.40=3	-0.9..0.9	1.00	Yes
18.64 P2	Power value P2 of the cosφ (P) characteristic par.18.40=3	0.01..1.00	0.50	Yes
18.65 cosfi (P2)	Setting the cosφ for the power P2 of the cosφ (P) characteristic par.18.40=3	-0.9..0.9	1.00	Yes
18.66 P3	Power value P3 of the cosφ (P) characteristic par.18.40=3	0.01..1.00	1.0	Yes
18.67 cosfi (P3)	Cosφ setting for the power P3 of the cosφ (P) characteristic par.18.40=3	-0.9..0.9	-0.9	Yes
18.70..18.79 reserve	-	-	-	-
18.80 Min F Reconnect	Minimum grid frequency when reconnecting	47.00..50.00 Hz dla fn=50 Hz (par. 18.02) 57.00..60.00 Hz dla fn=60 Hz (par. 18.02)	49.00 Hz 59.50 Hz	Yes
18.81 MaxFReconnect	Maximum mains frequency when reconnecting	50.00..52.00 Hz dla fn=50 Hz (par. 18.02) 60.00..62.00 Hz dla fn=60 Hz (par. 18.02)	50.05 Hz 60.20 Hz	Yes
18.82 MinURReconnect	Minimum mains voltage when reconnecting	50..100 %	85%	Yes
18.83 MaxURReconnect	Maximum mains voltage when reconnecting	100..120 %	110%	Yes
18.84 Observation time Reconnect	Observation time before reconnecting to the network	10..600 s	60 s	Yes
18.85 ReconnPowerRamp	Stromość narastania limitu mocy po ponownym podłączeniu	6..6000 %/min	10 %/min	Yes
18.90 MinFStart	Minimum grid frequency at start of operation	47.00..50.00 Hz dla fn=50 Hz (par. 18.02) 57.00..60.00 Hz dla fn=60 Hz (par. 18.02)	49.00 Hz 59.50 Hz	Yes
18.91 MaxFStart	Maximum mains frequency at start-up	50.00..52.00 Hz dla fn=50 Hz (par. 18.02) 60.00..62.00 Hz dla fn=60 Hz (par. 18.02)	50.05 Hz 60.20 Hz	Yes
18.92 MinUStart	The minimum voltage of the network at the start of operation	50..100 %	85%	Yes
18.93 MaxUStart	Maximum mains voltage at the start of operation	100..120 %	110%	Yes
18.94.Grid ObservationTime	Time of measuring electrical network parameters before starting work	10..600 s	60 s	Yes
18.95 Start.PowerRamp	The steepness of the increase of the power limit after the start of the system	0 - Disable 5..3000 %/min	0 - Disable	Yes
Group 19 - Active Rectifier (AcR)				
19.01 AcR mode	Active Rectifier mode	0 - AcR off 1 - AcR on when „ready” mode 2 - AcR on when „run” mode 3 - AcR on when „run” mode, motor starts after the AcR started. 4 - Idle mode	0	Yes
19.02 Grid voltage	Grid voltage	0 .. 3800 V	400 V	Yes
19.03 Grid freq.	Grid frequency	45.0 .. 66.0 Hz	50 Hz	Yes

Parameter / Name	Function	Available options / measurement unit	Factory setting	Change during operation
19.04 Grid volt. adj	Grid voltage adjust	0.85 .. 1.15	1.00	Yes
19.05 Switch. freq.	Switching frequency	2.0 .. 10.0 kHz	5.0 kHz	Yes
19.10 UDC refer.	UDC reference	0 .. 5500 V	665 V	Yes
19.20 Iq refer.	Iq reference	-30.0 .. 30.0 % (100%=In)	0.0 %	Yes
19.30 Absorb. limit	<i>Service parameter</i>	0.1 .. 220.0 % (100%=In)	100,0 %	Yes
19.31 Gener. limit	<i>Service parameter</i>	0.1 .. 220.0 % (100%=In)	100,0 %	Yes
19.40 Sine fil. induct	Inductance from the electric motor side	0.000 .. 32.767 mH	0.250 mH	Yes
19.41 Grid fil. induct	Inductance from the electrical grid side	0.000 .. 32.767 mH	0.070 mH	Yes
19.50 kp UDC	K of voltage regulator	0 .. 32767 %	160 %	Yes
19.51 Ti UDC	Ti of voltage regulator	0 .. 32767 %	140 %	Yes
19.55 kp Id	K of active current regulator	-3000 .. 32767 %	80 %	Yes
19.56 Ti Id	Ti of active current regulator	0 .. 32767 %	100 %	Yes
19.60 kp Iq	K of reactive current regulator	0 .. 32767 %	80 %	Yes
19.61 Ti Iq	Ti of reactive current regulator	0 .. 32767	100 %	Yes
19.70 Power feed forw.	Power feed forward	000 NO 001 YES	000 No	Yes
19.71 Active dump.	Active Damping	000 NO 001 YES	000 No	Yes
19.72 Auto UDC	Auto-adjustment of Udc ref.	000 NO 001 YES	000 No	No
Group 20 - Control configuration				
20.01 Ctrl. A/B	Switching ON variant A or B of control	000 Disabled – Control A enabled 001 DI1 .. 010 DI10 – A/B choice by using digital inputs DI1 .. DI10 531 Enabled – Control B enabled	000 Disabled	Yes
20.02 Ctrl. 1/2	Switching ON variant 1 or 2 of control	000 Disabled – Control 1 enabled 001 DI1 .. 010 DI10 – 1/2 choice by using digital inputs DI1 .. DI10 531 Enabled – Control 2 enabled	000 Disabled	Yes
20.10 Ref unit A1	Choice of a referencing-unit for Control A1	300 Keyb. ref. - frequency ref-unit from the panel 301 .. 304 PID out – referencing frequency by PID controller 305 .. 308 Motopot 1 – referencing by increase/decrease signals from motopotentiometer 309 Remote ref – referencing from remote control 310 .. 314 Ref an. - referencing frequency by signal from analog input AI0 .. AI4 315 .. 317 Comm chan. – referencing frequency from communication channel	300 Keyboard ref	Yes
20.11 Start A1	Choice of a source of START / STOP signal for Control A1	000 Keyboard 001 RS 002 Remote 1 003 Remote 2 004 Remote 3 005 Remote 4	000 Keyboard	Yes
20.12 Ref Torq A1	Torque referencing-unit for Control A1	310 .. 314 , 320 .. 329 Ref an. - referencing maximum torque by a signal from analog input 330 100% - maximum torque 100%	330 100%	Yes
20.20 Ref unit A2	Choice of a referencing-unit for Control A2	Same as 20.10	300 Keyboard ref	Yes
20.21 Start A2	Choice of a source of START / STOP signal for Control A2	Same as 20.11	000 Keyboard	Yes
20.22 Ref Torq A2	Torque referencing-unit for Control A2	Same as 20.12	330 100.0%	Yes
20.30 Ref unit B1	Choice of a referencing-unit for Control B1	Same as 20.10	309 Remote ref	Yes
20.31 Start B1	Choice of a source of START / STOP signal for Control B1	Same as 20.11	000 Keyboard	Yes
20.32 Ref Torq B1	Torque referencing-unit for Control B1	Same as 20.12	330 100%	Yes

Parameter / Name	Function	Available options / measurement unit	Factory setting	Change during operation
20.40 Ref unit B2	Choice of a referencing-unit for Control B2	Same as 20.10	309 Remote ref	Yes
20.41 Start B2	Choice of a source of START / STOP signal for Control B2	Same as 20.11	000 Keyboard	Yes
20.42 Ref Torq B2	Torque referencing-unit for Control B2	Same as 20.12	330 100%	Yes
20.50 Remote 1 mode	Variant of START/STOP Remote 1 control	000 ST. L/R Input 1 - Start/Stop Input 2 - Direction 001 ST. R ST. L Input 1 – Start right Input 2 – Start left 002 IM ST IM ST STOP Input 1 – Pulse (0V→24V): Start Input 2 – Pulse (24V→0V): Stop 003 IM ST IM ST LR Input 1 – Pulse (0V→24V): Start Input 2 – Pulse (24V→0V): Stop Input 3 – Direction 004 ONLY START Input 1 – Start/Stop	000 ST. L/R	Yes
20.51 Remote 1 Inp.1	Input 1 of Remote 1	000 Disabled – disabled 001 .. 010 – digital input DI1..DI10	000 DISABLED	Yes
20.52 Remote 1 Inp.2	Input 2 of Remote 1	000 Disabled – disabled 001 .. 010 – digital input DI1..DI10	000 DISABLED	Yes
20.53 Remote 1 Inp.3	Input 3 of Remote 1	000 Disabled – disabled 001 .. 010 – digital input DI1..DI10	000 DISABLED	Yes
20.60 Remote 2 mode	Variant of START/STOP Remote 2 control	The same as par. 20.50	000 ST. L/R	Yes
20.61 Remote 2 Inp.1	Input 1 of Remote 2	The same as par. 20.51	000 DISABLED	Yes
20.62 Remote 2 Inp.2	Input 2 of Remote 2	The same as par. 20.52	000 DISABLED	Yes
20.63 Remote 2 Inp.3	Input 3 of Remote 2	The same as par. 20.53	000 DISABLED	Yes
20.70 Remote 3 mode	Variant of START/STOP Remote 3 control	The same as par. 20.50	000 ST. L/R	Yes
20.71 Remote 3 Inp.1	Input 1 of Remote 3	The same as par. 20.51	000 DISABLED	Yes
20.72 Remote 3 Inp.2	Input 2 of Remote 3	The same as par. 20.52	000 DISABLED	Yes
20.73 Remote 3 Inp.3	Input 3 of Remote 3	The same as par. 20.53	000 DISABLED	Yes
20.80 Remote 4 mode	Variant of START/STOP Remote 4 control	The same as par. 20.50	000 ST. L/R	Yes
20.81 Remote 4 Inp.1	Input 1 of Remote 4	The same as par. 20.51	000 DISABLED	Yes
20.82 Remote 4 Inp.2	Input 2 of Remote 4	The same as par. 20.52	000 DISABLED	Yes
20.83 Remote 4 Inp.3	Input 3 of Remote 4	The same as par. 20.53	000 DISABLED	Yes
Group 21 – References				
21.01 Ref. min	Referenced frequency which corresponds to 0% of the referencing-unit	-550.0 .. 550.0 Hz	0.0 Hz	Yes
21.02 Ref. max	Ref. frequency which corresponds to 100% of the referencing-unit	0.0 .. 550.0 Hz Note: see also par. 13.40	50.0 Hz	Yes
21.10 F stop	Minimal absolute value of referenced frequency	0.0 .. 550.0 Hz	0.5 Hz	Yes
21.11 F stop mode	Stopping when $f <$ par. 21.10	Behavior of the frequency converter when referenced frequency is lower then “F stop” determined in par. 21.10: 000 Limit: the output frequency will stay at value set on par. 21.10 001 Stop: frequency converter will stop	000 Limit	Yes
21.16 Ref. delay	Ref-unit switching on delay	0.0 .. 12.0 s	0.0 s	Yes
21.17 Arming time	Delay of power transistors switching after start sequence	Combining with PCH 536 there is possibility to switch on the contactor in power circuit before switching on the power transistors. 0.00 .. 10.00 s	0.00 s	No

Parameter / Name	Function	Available options / measurement unit	Factory setting	Change during operation
21.20 Ref. resol.	Resolution of reference signal	000 0.1 Hz 001 0.01 Hz 002 1 rpm 003 0.1 rpm	000 0.1 Hz	No
Group 22 - Motopotencjometer				
22.01 Mtp1 adr up	Source of "increase" signal for Motopotentiometer 1 referencing-unit	000 Disabled 001 DI1 .. 010 DI10 - increase ref.-unit, when there is a voltage supplied on digital input DI1 .. DI10	000 Disabled	Yes
22.02 Mtp1 adr down	Source of "decrease" signal for Motopotentiometer 1 referencing-unit	000 Disabled 001 DI1 .. 010 DI10 - decrease ref.-unit, when there is a voltage supplied on digital input DI1 .. DI10	000 Disabled	Yes
22.03 Motopot1 mode	Motopotentiometer 1 mode	000 – sending STOP signal (by pushing STOP button, through RS or other possibilities) causes resetting of motopotentiometer settings. 001 – value of motopotentiometer setting is stored in memory. There is no possibility of changing this setting during stoppage. 002 – value of current referencing-unit setting traced by motopotentiometer. Applied for gentle transmission from current ref.-unit to motopotentiometer 003 – value of motopotentiometer setting stored in the memory. There is a possibility of changing this setting during stoppage. <u>Note:</u> 000, 001, 002: modes applied when current ref.-unit (par. 20.10, 20.20, 20.30, 20.40) is set on Motopot 1 .. Motopot 4 003: mode independent of current ref.-unit choice	002 Refer. traced	Yes
22.04 Motopot1 time	Time of increase/decrease of Motopotentiometer 1 referencing-unit	0.0 .. 320.0 s	10.0 s	Yes
22.11 Mtp2 adr up	Source of "increase" signal for Motopotentiometer 2 referencing-unit	The same as par. 22.01 See par. 22.01	000 Disabled	Yes
22.12 Mtp2 adr down	Source of "decrease" signal for Motopotentiometer 2 referencing-unit	The same as par. 22.02 See par. 22.02	000 Disabled	Yes
22.13 Motopot2 mode	Motopotentiometer 2 mode	The same as par. 22.03 See par. 22.03	002 Refer. traced	Yes
22.14 Motopot2 time	Time of increase/decrease of Motopotentiometer 2 referencing-unit	The same as par. 22.04 See par. 22.04	10.0 s	Yes
22.21 Mtp3 adr up	Source of "increase" signal for Motopotentiometer 3 referencing-unit	The same as par. 22.01 See par. 22.01	000 Disabled	Yes
22.22 Mtp3 adr down	Source of "decrease" signal for Motopotentiometer 3 referencing-unit	The same as par. 22.02 See par. 22.02	000 Disabled	Yes
22.23 Motopot3 mode	Motopotentiometer 3 mode	The same as par. 22.03 See par. 22.03	002 Refer. traced	Yes
22.24 Motopot3 time	Time of increase/decrease of Motopotentiometer 3 referencing-unit	The same as par. 22.04 See par. 22.04	10.0 s	Yes
22.31 Mtp4 adr up	Source of "increase" signal for Motopotentiometer 4 referencing-unit	The same as par. 22.01 See par. 22.01	000 Disabled	Yes
22.32 Mtp4 adr down	Source of "decrease" signal for Motopotentiometer 4 referencing-unit	The same as par. 22.02 See par. 22.02	000 Disabled	Yes

Parameter / Name	Function	Available options / measurement unit	Factory setting	Change during operation
22.33 Motopot4 mode	Motopotentiometer 4 mode	The same as par. 22.03 See par. 22.03	002 Refer. traced	Yes
22.34 Motopot4 time	Time of increase/decrease of Motopotentiometer 4 referencing-unit	The same as par. 22.04 See par. 22.04	10.0 s	Yes
Group 23 - Const. speed				
23.01 Adr const 0	Source of signal for referencing Constant 0 speeds	000 Disabled - Off 001 DI1 .. 010 DI10 - On when there is a voltage supplied on digital input DI1 .. DI10 531 Yes – always On	000 Disabled	Yes
23.02 Adr const 1	Source of signal for referencing Constant 1 speeds	The same as par. 23.01	000 Disabled	Yes
23.03 Adr const 2	Source of signal for referencing Constant 2 speeds	The same as par. 23.01	000 Disabled	Yes
23.04 Adr const 3	Source of signal for referencing Constant 3 speeds	The same as par. 23.01	000 Disabled	Yes
23.06 Const 1	Constant frequency 1	-550.0 .. 500.0 Hz	10.0 Hz	Yes
23.07 Const 2	Constant frequency 2	-550.0 .. 500.0 Hz	20.0 Hz	Yes
23.08 Const 3	Constant frequency 3	-550.0 .. 500.0 Hz	25.0 Hz	Yes
23.09 Const 4	Constant frequency 4	-550.0 .. 500.0 Hz	30.0 Hz	Yes
23.10 Const 5	Constant frequency 5	-550.0 .. 500.0 Hz	40.0 Hz	Yes
23.11 Const 6	Constant frequency 6	-550.0 .. 500.0 Hz	45.0 Hz	Yes
23.12 Const 7	Constant frequency 7	-550.0 .. 500.0 Hz	50.0 Hz	Yes
23.13 Const 8	Constant frequency 8	-550.0 .. 500.0 Hz	50.0 Hz	Yes
23.14 Const 9	Constant frequency 9	-550.0 .. 500.0 Hz	50.0 Hz	Yes
23.15 Const 10	Constant frequency 10	-550.0 .. 500.0 Hz	50.0 Hz	Yes
23.16 Const 11	Constant frequency 11	-550.0 .. 500.0 Hz	50.0 Hz	Yes
23.17 Const 12	Constant frequency 12	-550.0 .. 500.0 Hz	50.0 Hz	Yes
23.18 Const 13	Constant frequency 13	-550.0 .. 500.0 Hz	50.0 Hz	Yes
23.19 Const 14	Constant frequency 14	-550.0 .. 500.0 Hz	50.0 Hz	Yes
23.20 Const 15	Constant frequency 15	-550.0 .. 500.0 Hz	50.0 Hz	Yes
Group 24 - Analog in.				
24.01 Cfg. A0 inp	Configuration of analog input AI0	000 0-10 V: 0V=0%, 10V=100% 001 10-0 V: 10V=100%, 0V=0% 002 2-10 V: 2V=0%, 10V=100%	000 0-10 V	Yes
24.02 Scale A0 inp	Scale of analog referencing-unit Ref. AI0	-500.0 .. 500.0 %	100.0%	Yes
24.03 Offs. A0 inp	Offset of analog referencing-unit Ref. AI0	-500.0 .. 500.0 %	0.0 %	Yes
24.04 Filter A0 inp	Constant of time of lowpass AI0 filter	0.00 .. 50.00 s	0.10 s	Yes
24.11 Cfg. A1 inp	Configuration of analog input AI1	000 0-10 V: 0V=0%, 10V=100% 001 10-0 V: 10V=100%, 0V=0% 002 2-10 V: 2V=0%, 10V=100% 003 10-2 V: 10V=100%, 2V=0% 004 0-20 mA: 0mA=0%, 20mA=100% 005 20-0 mA: 20mA=100%, 0mA=0% 006 4-20mA: 4mA=0%, 20mA=100% 007 20-4 mA: 20mA=100%, 4mA=0%	000 0-10 V	Yes
24.12 Scale A1 inp	Scale of analog referencing-unit Ref. AI1	-500.0 .. 500.0 %	100.0%	Yes
24.13 Offs. A1 inp	Offset of analog referencing-unit Ref. AI1	-500.0 .. 500.0 %	0.0 %	Yes
24.14 Filter A1 inp	Constant of time of lowpass AI1 filter	0.00 .. 50.00 s	0.10 s	Yes
24.21 Cfg. A2 inp	Configuration of analog input AI2	The same as par. 24.11	000 0-10 V	Yes
24.22 Scale A2 inp	Scale of analog referencing-unit Ref. AI2	-500.0 .. 500.0 %	100.0%	Yes
24.23 Offs. A2 inp	Offset of analog referencing-unit Ref. AI2	-500.0..500.0 %	0.0 %	Yes
24.24 Filter A2 inp	Constant of time of lowpass AI2 filter	0.00 .. 50.00 s	0.10 s	Yes
24.31 Cfg. A3 inp	Configuration of analog input AI3	The same as par. 24.11	000 0-10 V	Yes

Parameter / Name	Function	Available options / measurement unit	Factory setting	Change during operation
24.32 Scale A3 inp	Scale of analog referencing-unit Ref. AI3	-500.0..500.0 %	100.0%	Yes
24.33 Offs. A3 inp	Offset of analog referencing-unit Ref. AI3	-500.0 .. 500.0 %	0.0 %	Yes
24.34 Filter A3 inp	Constant of time of lowpass AI3 filter	0.00 .. 50.00 s	0.10 s	Yes
24.41 Cfg. A4 inp	Configuration of analog input AI4	The same as par. 24.11	000 0-10 V	Yes
24.42 Scale A4 inp	Scale of analog referencing-unit Ref. AI4	-500.0 .. 500.0 %	100%	Yes
24.43 Offs. A4 inp	Offset of analog referencing-unit Ref. AI4	-500.0 .. 500.0 %	0%	Yes
24.44 Filter A4 inp	Constant of time of lowpass AI4 filter	0.00 .. 50.00 s	0.10 s	Yes
Group 25 - Analog out.				
25.01 Cfg. A1 out	Configuration of analog output AO1	000 0-10V: 0V=0%, 10V=100% 001 10-0 V: 10V=0%, 0V=100% 002 2-10 V: 2V=0%, 10V=100% 003 10-2 V: 10V=0%, 2V=100% 004 0-20 mA: 0mA=0%, 20mA=100% 005 20-0 mA: 20mA=0%, 0mA=100% 006 4-20 mA: 4mA=0%, 20mA=100% 007 20-4 mA: 20mA=0%, 4mA=100%	000 0-10V	Yes
25.02 Src. A1 out	Choice of signal for analog output AO1	230 Rotation % speed with a sign 0.0 % = -Nn, 50.0 % = 0, 100.0 % = nn 231 Out freq % output frequency 100.0 % = fn 232 Ref freq % reference frequency 100.0 % = fn 233 Curr % output current 100.0 % = In 234 Torq % load with a sign 100.0 % = 2Mn, 50.0 % = 0, 0.0 % = -2Mn 235 Power % Output power % 236 Drive volt % Output voltage %	230 Rotation %	Yes
25.03 Scale A1 out	Scale of analog output AO1	0.0 .. 500.0 %	100 %	Yes
25.04 Offset A1 out	Offset of analog output AO1	-500.0 .. 500.0	0,0 %	Yes
25.05 Filter A1 out	Constant of time of lowpass AO1 filter	0.00 .. 50.00	0.10	Yes
25.11 Cfg. A2 out	Configuration of analog output AO2	The same as par. 25.01	000 0-10V	Yes
25.12 Src. A2 out	Choice of signal for analog output AO2	The same as par. 25.02	232 Ref freq %	Yes
25.13 Scale A2 out	Scale of analog output AO2	0.0 .. 500.0 %	100.0 %	Yes
25.14 Offset A2 out	Offset of analog output AO2	-500.0 .. 500.0	0.0 %	Yes
25.15 Filter A2 out	Constant of time of lowpass AO2 filter	0.00 .. 50.00	0.10 s	Yes
Group 26 - Digital inputs				
26.01 Op. perm.	External operation permission	000 Denied – operation denied 001 Input 1 .. 010 Input 10 – operation allowed when there is a voltage supplied on digital input DI1 .. DI10 531 Enabled - operation allowed	531 Allowed	Yes
26.02 Op. block.	External operation blocking	000 Disabled - without operation blocking 001 Input 1 .. 010 Input 10 - blocking active, when there is voltage supplied on digital inputs DI1 .. DI10	000 Disabled	Yes
26.03 Em. stop	Emergency Stop	000 Disabled - no possibility of emergency stopping 001 Input 1 .. 010 Input 10 - emergency stop by one of a digital inputs DI1 .. DI10	000 Disabled	Yes

Parameter / Name	Function	Available options / measurement unit	Factory setting	Change during operation
26.10 Enable ACR	Enable active rectifier AcR	000 Denied - Off 001 DI1 .. 010 DI10 - On when there is a voltage supplied on digital inputs DI1 .. DI10 531 Allowed - always On	000 Denied	Yes
26.11 Ext. reset	Source of external reset	000 Disabled - no possibility of external erasing a fault message 001 Input 1 .. 010 Input 10 - erasing a fault by digital inputs DI1 .. DI10	000 Disabled	Yes
Group 27 – Relay outputs: K1 - K16				
27.01 F thresh. 1	Threshold frequency 1	0.0 .. 550.0 Hz	25.0 Hz	Yes
27.02 F thresh. 2	Threshold frequency 2	0.0 .. 550.0 Hz	45.0 Hz	Yes
27.03 Temp.1 min	Minimum of temperature 1 (PCH 524)	0 .. 120 °C	50 °C	Yes
27.04 Temp.1 max	Maximum of temperature 1 (PCH 524)	0 .. 120 °C	75 °C	Yes
27.05 Temp.2 min	Minimum of temperature 2 (PCH 525)	0 .. 120 °C	37 °C	Yes
27.06 Temp.2 max	Maximum of temperature 2 (PCH 525)	0 .. 120 °C	40 °C	Yes
27.10 PT100 1 min	Minimum temperature of PT100 1 (PCH 528)	-200.0 .. 800.0 °C	0 °C	Yes
27.11 PT100 1 max	Maximum temperature of PT100 1 (PCH 528)	-200.0 .. 800.0 °C	0 °C	Yes
27.12 PT100 2 min	Minimum temperature of PT100 2 (PCH 529)	-200.0 .. 800.0 °C	0 °C	Yes
27.13 PT100 2 max	Maximum temperature of PT100 2 (PCH 529)	-200.0 .. 800.0 °C	0 °C	Yes

Parameter / Name	Function	Available options / measurement unit	Factory setting	Change during operation
27.40 Rel. 1 adr	Function of relay K1	500 Inactive: relay not active 501 Start keypad: 000 keyboard is chosen as Start/Stop 502 Start dig in: 002 Remote 1 .. 005 Remote 4 is chosen as Start/Stop 503 Start comm: 001 RS is chosen as Start/Stop 504 Keypad dir: direction signal to the left was referenced from the Control Panel 505 Digital dir: direction signal to the left was referenced from the Remote 506 Refer dir: output frequency sign is negative (-) 507 Under fstop: f is under fstop 508 Start allow: Start is allowed (yellow LED is lighted up) 509 Reverse: reverse is present 510 Control A/B: Control B is chosen 511 Control 1/2: Control 2 is chosen 512 Comm allowed: communication is allowed (par. 40.07) 513 F const: Fconst is active (par. 23.1 - 23.4) 514 Run: a voltage is supplied to the motor 515 Ready: device is ready to work 516 Fault: a fault has occurred 517 Not fault: not fault 518 Alarm: warning/alarm is active 519 Alarm / fault: warning/alarm or fault is active 520 Blockade: inverter is blocked, can't start 523 Freq lvl 1: f threshold 1 exceeded 522 Freq lvl 2: f threshold 2 exceeded 523 Freq reached: referenced frequency reached 524 Temp lvl 1: level 1 programmed temperature of heatsink exceeded 525 Temp lvl 2: level 2 programmed temperature of heatsink exceeded 526 Curr limit: current limit exceeded 527 Brake: external brake control 528 PT100 lvl 1: PT100 temperature reached threshold 1 529 PT100 lvl 2: PT100 temperature reached threshold 2 530 No/Disabled: relay not active 531 Yes/Enabled: relay is always active 532 PID1 sleep: PID1 is in sleep state 533 PID2 sleep: PID2 is in sleep state 534 PID3 sleep: PID3 is in sleep state 535 PID4 sleep: PID1 is in sleep state 536 Start Output / arming: Switching On output contactors. The inverter will start a while after of switching on the contactors.	510 Control A/B	Yes
27.41 Rel. 1 time ON	Relay K1 time ON	The delay ON time of relay 1 0.00 .. 100.00 s (0.00 = without delay)	0.00s	Yes
27.42 Rel. 1 time OFF	Relay K1 time OFF	The delay OFF time of relay 1. 0.00 .. 100.00 s (0.00 = without delay)	0.00s	Yes
27.43 Rel. 1 inv	Relay K1 signal inversion	000 No 001 Yes	000 No	Yes
27.44 Rel. 2 adr	Function of Relay K2	The same as par. 27.40	500 Inactive	Yes
27.45 Rel. 2 time ON	Relay K2 time ON	The delay ON time of relay 2. 0.00 .. 100.00 s (0.00 = without delay)	0.00s	Yes
27.46 Rel. 2 time OFF	Relay K2 time OFF	The delay OFF time of relay 2. 0.00 .. 100.00 s (0.00 = without delay)	0.00s	Yes
27.47 Rel. 2 inv	Relay K2 signal inversion	000 No 001 Yes	000 No	Yes
27.48 Rel. 3 adr	Function of Relay K3	The same as par. 27.40	500 Inactive	Yes
27.49 Rel. 3 time ON	Relay K3 time ON	The delay ON time of relay 3. 0.00 .. 100.00 s (0.00 = without delay)	0.00s	Yes
27.50 Rel. 3 time OFF	Relay K3 time OFF	The delay OFF time of relay 3. 0.00 .. 100.00 s (0.00 = without delay)	0.00s	Yes

Parameter / Name	Function	Available options / measurement unit	Factory setting	Change during operation
27.51 Rel. 3 inv	Relay K3 signal inversion	000 No 001 Yes	000 No	Yes
27.52 Rel. 4 adr	Function of Relay K4	The same as par. 27.40	500 Inactive	Yes
27.53 Rel. 4 time ON	Relay K4 time ON	The delay ON time of relay 4. 0.00 .. 100.00 s (0.00 = without delay)	0.00s	Yes
27.54 Rel. 4 time OFF	Relay K4 time OFF	The delay OFF time of relay 4. 0.00 .. 100.00 s (0.00 = without delay)	0.00s	Yes
27.55 Rel. 4 inv	Relay K4 signal inversion	000 No 001 Yes	000 No	Yes
27.56 Rel. 5 adr	Function of Relay K5	The same as par. 27.40	500 Inactive	Yes
27.57 Rel. 5 time ON	Relay K5 time ON	The delay ON time of relay 5. 0.00 .. 100.00 s (0.00 = without delay)	0.00s	Yes
27.58 Rel. 5 time OFF	Relay K5 time OFF	The delay OFF time of relay 5. 0.00 .. 100.00 s (0.00 = without delay)	0.00s	Yes
27.59 Rel. 5 inv	Relay K5 signal inversion	000 No 001 Yes	000 No	Yes
27.60 Rel. 6 adr	Function of Relay K6	The same as par. 27.40	500 Inactive	Yes
27.61 Rel. 6 time ON	Relay K6 time ON	The delay ON time of relay 6. 0.00 .. 100.00 s (0.00 = without delay)	0.00s	Yes
27.62 Rel. 6 time OFF	Relay K6 time OFF	The delay OFF time of relay 6. 0.00 .. 100.00 s (0.00 = without delay)	0.00s	Yes
27.63 Rel. 6 inv	Relay K6 signal inversion	000 No 001 Yes	000 No	Yes
27.64 Rel. 7 adr	Function of Relay K7	The same as par. 27.40	500 Inactive	Yes
27.65 Rel. 7 time ON	Relay K7 time ON	The delay ON time of relay 7. 0.00 .. 100.00 s (0.00 = without delay)	0.00s	Yes
27.66 Rel. 7 time OFF	Relay K7 time OFF	The delay OFF time of relay 7. 0.00 .. 100.00 s (0.00 = without delay)	0.00s	Yes
27.67 Rel. 7 inv	Relay K7 signal inversion	000 No 001 Yes	000 No	Yes
27.68 Rel. 8 adr	Function of Relay K8	The same as par. 27.40	500 Inactive	Yes
27.69 Rel. 8 time ON	Relay K8 time ON	The delay ON time of relay 8. 0.00 .. 100.00 s (0.00 = without delay)	0.00s	Yes
27.70 Rel. 8 time OFF	Relay K8 time OFF	The delay OFF time of relay 8. 0.00 .. 100.00 s (0.00 = without delay)	0.00s	Yes
27.71 Rel. 8 inv	Relay K8 signal inversion	000 No 001 Yes	000 No	Yes
27.75 Rel. 11 adr	Function of Relay K11	The same as par. 27.40	500 Inactive	Yes
27.76 Rel. 11 time ON	Relay K11 time ON	The delay ON time of relay 11. 0.00 .. 100.00 s (0.00 = without delay)	0.00s	Yes
27.77 Rel. 11 time OFF	Relay K11 time OFF	The delay OFF time of relay 11. 0.00 .. 100.00 s (0.00 = without delay)	0.00s	Yes
27.78 Rel. 11 inv	Relay K11 signal inversion	000 No 001 Yes	000 No	Yes
27.79 Rel. 12 adr	Function of Relay K12	The same as par. 27.40	500 Inactive	Yes
27.80 Rel. 12 time ON	Relay K12 time ON	The delay ON time of relay 12. 0.00 .. 100.00 s (0.00 = without delay)	0.00s	Yes
27.81 Rel. 12 time OFF	Relay K12 time OFF	The delay OFF time of relay 12. 0.00 .. 100.00 s (0.00 = without delay)	0.00s	Yes
27.82 Rel. 12 inv	Relay K12 signal inversion	000 No 001 Yes	000 No	Yes
27.83 Rel. 13 adr	Function of Relay K13	The same as par. 27.40	500 Inactive	Yes
27.84 Rel. 13 time ON	Relay K13 time ON	The delay ON time of relay 13. 0.00 .. 100.00 s (0.00 = without delay)	0.00s	Yes
27.85 Rel. 13 time OFF	Relay K13 time OFF	The delay OFF time of relay 13. 0.00 .. 100.00 s (0.00 = without delay)	0.00s	Yes
27.86 Rel. 13 inv	Relay K13 signal inversion	000 No 001 Yes	000 No	Yes
27.87 Rel. 14 adr	Function of Relay K14	The same as par. 27.40	500 Inactive	Yes
27.88 Rel. 14 time ON	Relay K14 time ON	The delay ON time of relay 14. 0.00 .. 100.00 s (0.00 = without delay)	0.00s	Yes
27.89 Rel. 14 time OFF	Relay K14 time OFF	The delay OFF time of relay 14. 0.00 .. 100.00 s (0.00 = without delay)	0.00s	Yes
27.90 Rel. 14 inv	Relay K14 signal inversion	000 No 001 Yes	000 No	Yes
27.91 Rel. 15 adr	Function of Relay K15	The same as par. 27.40	500 Inactive	Yes
27.92 Rel. 15 time ON	Relay K15 time ON	The delay ON time of relay 15. 0.00 .. 100.00 s (0.00 = without delay)	0.00s	Yes

Parameter / Name	Function	Available options / measurement unit	Factory setting	Change during operation
27.93 Rel. 15 time OFF	Relay K15 time OFF	The delay OFF time of relay 15. 0.00 .. 100.00 s (0.00 = without delay)	0.00s	Yes
27.94 Rel. 15 inv	Relay K15 signal inversion	000 No 001 Yes	000 No	Yes
27.95 Rel. 16 adr	Function of Relay K16	The same as par. 27.40	500 Inactive	Yes
27.96 Rel. 16 time ON	Relay K16 time ON	The delay ON time of relay 16. 0.00 .. 100.00 s (0.00 = without delay)	0.00s	Yes
27.97 Rel. 16 time OFF	Relay K16 time OFF	The delay OFF time of relay 16. 0.00 .. 100.00 s (0.00 = without delay)	0.00s	Yes
27.98 Rel. 16 inv	Relay K16 signal inversion	000 No 001 Yes	000 No	Yes
Group 28 - Digital outputs: 21 - 56				
28.00 Rel. 21 adr	Function of Relay K21	The same as par. 27.40	500 Inactive	Yes
28.01 Rel. 21 time ON	Relay K21 time ON	The delay ON time of relay 23. 0.00 .. 100.00 s (0.00 = without delay)	0.00s	Yes
28.02 Rel. 21 time OFF	Relay K21 time OFF	The delay OFF time of relay 23. 0.00 .. 100.00 s (0.00 = without delay)	0.00s	Yes
28.03 Rel. 21 inv	Relay K21 signal inversion	000 No 001 Yes	000 No	Yes
28.04 Rel. 22 adr	Function of Relay K22	The same as par. 27.40	500 Inactive	Yes
28.05 Rel. 22 time ON	Relay K22 time ON	The delay ON time of relay 22. 0.00 .. 100.00 s (0.00 = without delay)	0.00s	Yes
28.06 Rel. 22 time OFF	Relay K22 time OFF	The delay OFF time of relay 22. 0.00 .. 100.00 s (0.00 = without delay)	0.00s	Yes
28.07 Rel. 22 inv	Relay K22 signal inversion	000 No 001 Yes	000 No	Yes
28.08 Rel. 23 adr	Function of Relay K23	The same as par. 27.40	500 Inactive	Yes
28.09 Rel. 23 time ON	Relay K23 time ON	The delay ON time of relay 23. 0.00 .. 100.00 s (0.00 = without delay)	0.00s	Yes
28.10 Rel. 23 time OFF	Relay K23 time OFF	The delay OFF time of relay 23. 0.00 .. 100.00 s (0.00 = without delay)	0.00s	Yes
28.11 Rel. 23 inv	Relay K23 signal inversion	000 No 001 Yes	000 No	Yes
28.12 Rel. 24 adr	Function of Relay K24	The same as par. 27.40	500 Inactive	Yes
28.13 Rel. 24 time ON	Relay K24 time ON	The delay ON time of relay 24. 0.00 .. 100.00 s (0.00 = without delay)	0.00s	Yes
28.14 Rel. 24 time OFF	Relay K24 time OFF	The delay OFF time of relay 24. 0.00 .. 100.00 s (0.00 = without delay)	0.00s	Yes
28.15 Rel. 24 inv	Relay K24 signal inversion	000 No 001 Yes	000 No	Yes
28.16 Rel. 25 adr	Function of Relay K25	The same as par. 27.40	500 Inactive	Yes
28.17 Rel. 25 time ON	Relay K25 time ON	The delay ON time of relay 25. 0.00 .. 100.00 s (0.00 = without delay)	0.00s	Yes
28.18 Rel. 25 time OFF	Relay K25 time OFF	The delay OFF time of relay 25. 0.00 .. 100.00 s (0.00 = without delay)	0.00s	Yes
28.19 Rel. 25 inv	Relay K25 signal inversion	000 No 001 Yes	000 No	Yes
28.20 Rel. 26 adr	Function of Relay K26	The same as par. 27.40	500 Inactive	Yes
28.21 Rel. 26 time ON	Relay K26 time ON	The delay ON time of relay 26. 0.00 .. 100.00 s (0.00 = without delay)	0.00s	Yes
28.22 Rel. 26 time OFF	Relay K26 time OFF	The delay OFF time of relay 26. 0.00 .. 100.00 s (0.00 = without delay)	0.00s	Yes
28.23 Rel. 26 inv	Relay K26 signal inversion	000 No 001 Yes	000 No	Yes
28.25 Rel. 31 adr	Function of Relay K31	The same as par. 27.40	500 Inactive	Yes
28.26 Rel. 31 time ON	Relay K31 time ON	The delay ON time of relay 31. 0.00 .. 100.00 s (0.00 = without delay)	0.00s	Yes
28.27 Rel. 31 time OFF	Relay K31 time OFF	The delay OFF time of relay 31. 0.00 .. 100.00 s (0.00 = without delay)	0.00s	Yes
28.28 Rel. 31 inv	Relay K31 signal inversion	000 No 001 Yes	000 No	Yes
28.29 Rel. 32 adr	Function of Relay K32	The same as par. 27.40	500 Inactive	Yes
28.30 Rel. 32 time ON	Relay K32 time ON	The delay ON time of relay 32. 0.00 .. 100.00 s (0.00 = without delay)	0.00s	Yes
28.31 Rel. 32 time OFF	Relay K32 time OFF	The delay OFF time of relay 32. 0.00 .. 100.00 s (0.00 = without delay)	0.00s	Yes
28.32 Rel. 32 inv	Relay K32 signal inversion	000 No 001 Yes	000 No	Yes
28.33 Rel. 33 adr	Function of Relay K33	The same as par. 27.40	500 Inactive	Yes

Parameter / Name	Function	Available options / measurement unit	Factory setting	Change during operation
28.34 Rel. 33 time ON	Relay K33 time ON	The delay ON time of relay 33. 0.00 .. 100.00 s (0.00 = without delay)	0.00s	Yes
28.35 Rel. 33 time OFF	Relay K33 time OFF	The delay OFF time of relay 33. 0.00 .. 100.00 s (0.00 = without delay)	0.00s	Yes
28.36 Rel. 33 inv	Relay K33 signal inversion	000 No 001 Yes	000 No	Yes
28.37 Rel. 34 adr	Function of Relay K34	The same as par. 27.40	500 Inactive	Yes
28.38 Rel. 34 time ON	Relay K34 time ON	The delay ON time of relay 34. 0.00 .. 100.00 s (0.00 = without delay)	0.00s	Yes
28.39 Rel. 34 time OFF	Relay K34 time OFF	The delay OFF time of relay 34. 0.00 .. 100.00 s (0.00 = without delay)	0.00s	Yes
28.40 Rel. 34 inv	Relay K34 signal inversion	000 No 001 Yes	000 No	Yes
28.41 Rel. 35 adr	Function of Relay K35	The same as par. 27.40	500 Inactive	Yes
28.42 Rel. 35 time ON	Relay K35 time ON	The delay ON time of relay 35. 0.00 .. 100.00 s (0.00 = without delay)	0.00s	Yes
28.43 Rel. 35 time OFF	Relay K35 time OFF	The delay OFF time of relay 35. 0.00 .. 100.00 s (0.00 = without delay)	0.00s	Yes
28.44 Rel. 35 inv	Relay K35 signal inversion	000 No 001 Yes	000 No	Yes
28.45 Rel. 36 adr	Function of Relay K36	The same as par. 27.40	500 Inactive	Yes
28.46 Rel. 36 time ON	Relay K36 time ON	The delay ON time of relay 36. 0.00 .. 100.00 s (0.00 = without delay)	0.00s	Yes
28.47 Rel. 36 time OFF	Relay K36 time OFF	The delay OFF time of relay 36. 0.00 .. 100.00 s (0.00 = without delay)	0.00s	Yes
28.48 Rel. 36 inv	Relay K36 signal inversion	000 No 001 Yes	000 No	Yes
28.50 Rel. 41 adr	Function of Relay K41	The same as par. 27.40	500 Inactive	Yes
28.51 Rel. 41 time ON	Relay K41 time ON	The delay ON time of relay 36. 0.00 .. 100.00 s (0.00 = without delay)	0.00s	Yes
28.52 Rel. 41 time OFF	Relay K41 time OFF	The delay OFF time of relay 36. 0.00 .. 100.00 s (0.00 = without delay)	0.00s	Yes
28.53 Rel. 41 inv	Relay K41 signal inversion	000 No 001 Yes	000 No	Yes
28.54 Rel. 42 adr	Function of Relay K42	The same as par. 27.40	500 Inactive	Yes
28.55 Rel. 42 time ON	Relay K42 time ON	The delay ON time of relay 42. 0.00 .. 100.00 s (0.00 = without delay)	0.00s	Yes
28.56 Rel. 42 time OFF	Relay K42 time OFF	The delay OFF time of relay 42. 0.00 .. 100.00 s (0.00 = without delay)	0.00s	Yes
28.57 Rel. 42 inv	Relay K42 signal inversion	000 No 001 Yes	000 No	Yes
28.58 Rel. 43 adr	Function of Relay K43	The same as par. 27.40	500 Inactive	Yes
28.59 Rel. 43 time ON	Relay K43 time ON	The delay ON time of relay 43. 0.00 .. 100.00 s (0.00 = without delay)	0.00s	Yes
28.60 Rel. 43 time OFF	Relay K43 time OFF	The delay OFF time of relay 43. 0.00 .. 100.00 s (0.00 = without delay)	0.00s	Yes
28.61 Rel. 43 inv	Relay K43 signal inversion	000 No 001 Yes	000 No	Yes
28.62 Rel. 44 adr	Function of Relay K44	The same as par. 27.40	500 Inactive	Yes
28.63 Rel. 44 time ON	Relay K44 time ON	The delay ON time of relay 44. 0.00 .. 100.00 s (0.00 = without delay)	0.00s	Yes
28.64 Rel. 44 time OFF	Relay K44 time OFF	The delay OFF time of relay 44. 0.00 .. 100.00 s (0.00 = without delay)	0.00s	Yes
28.65 Rel. 44 inv	Relay K44 signal inversion	000 No 001 Yes	000 No	Yes
28.66 Rel. 45 adr	Function of Relay K45	The same as par. 27.40	500 Inactive	Yes
28.67 Rel. 45 time ON	Relay K45 time ON	The delay ON time of relay 45. 0.00 .. 100.00 s (0.00 = without delay)	0.00s	Yes
28.68 Rel. 45 time OFF	Relay K45 time OFF	The delay OFF time of relay 45. 0.00 .. 100.00 s (0.00 = without delay)	0.00s	Yes
28.69 Rel. 45 inv	Relay K45 signal inversion	000 No 001 Yes	000 No	Yes
28.70 Rel. 46 adr	Function of Relay K46	The same as par. 27.40	500 Inactive	Yes
28.71 Rel. 46 time ON	Relay K46 time ON	The delay ON time of relay 46. 0.00 .. 100.00 s (0.00 = without delay)	0.00s	Yes
28.72 Rel. 46 time OFF	Relay K46 time OFF	The delay OFF time of relay 46. 0.00 .. 100.00 s (0.00 = without delay)	0.00s	Yes
28.73 Rel. 46 inv	Relay K46 signal inversion	000 No 001 Yes	000 No	Yes

Parameter / Name	Function	Available options / measurement unit	Factory setting	Change during operation
28.75 Rel. 51 adr	Function of Relay K51	The same as par. 27.40	500 Inactive	Yes
28.76 Rel. 51 time ON	Relay K51 time ON	The delay ON time of relay 51. 0.00 .. 100.00 s (0.00 = without delay)	0.00s	Yes
28.77 Rel. 51 time OFF	Relay K51 time OFF	The delay OFF time of relay 51. 0.00 .. 100.00 s (0.00 = without delay)	0.00s	Yes
28.78 Rel. 51 inv	Relay K51 signal inversion	000 No 001 Yes	000 No	Yes
28.79 Rel. 52 adr	Function of Relay K52	The same as par. 27.40	500 Inactive	Yes
28.80 Rel. 52 time ON	Relay K52 time ON	The delay ON time of relay 52. 0.00 .. 100.00 s (0.00 = without delay)	0.00s	Yes
28.81 Rel. 52 time OFF	Relay K52 time OFF	The delay OFF time of relay 52. 0.00 .. 100.00 s (0.00 = without delay)	0.00s	Yes
28.82 Rel. 52 inv	Relay K52 signal inversion	000 No 001 Yes	000 No	Yes
28.83 Rel. 53 adr	Function of Relay K53	The same as par. 27.40	500 Inactive	Yes
28.84 Rel. 53 time ON	Relay K53 time ON	The delay ON time of relay 53. 0.00 .. 100.00 s (0.00 = without delay)	0.00s	Yes
28.85 Rel. 53 time OFF	Relay K53 time OFF	The delay OFF time of relay 53. 0.00 .. 100.00 s (0.00 = without delay)	0.00s	Yes
28.86 Rel. 53 inv	Relay K53 signal inversion	000 No 001 Yes	000 No	Yes
28.87 Rel. 54 adr	Function of Relay K54	The same as par. 27.40	500 Inactive	Yes
28.88 Rel. 54 time ON	Relay K54 time ON	The delay ON time of relay 54. 0.00 .. 100.00 s (0.00 = without delay)	0.00s	Yes
28.89 Rel. 54 time OFF	Relay K54 time OFF	The delay OFF time of relay 54. 0.00 .. 100.00 s (0.00 = without delay)	0.00s	Yes
28.90 Rel. 54 inv	Relay K54 signal inversion	000 No 001 Yes	000 No	Yes
28.91 Rel. 55 adr	Function of Relay K55	The same as par. 27.40	500 Inactive	Yes
28.92 Rel. 55 time ON	Relay K55 time ON	The delay ON time of relay 55. 0.00 .. 100.00 s (0.00 = without delay)	0.00s	Yes
28.93 Rel. 55 time OFF	Relay K55 time OFF	The delay OFF time of relay 55. 0.00 .. 100.00 s (0.00 = without delay)	0.00s	Yes
28.94 Rel. 55 inv	Relay K55 signal inversion	000 No 001 Yes	000 No	Yes
28.95 Rel. 56 adr	Function of Relay K56	The same as par. 27.40	500 Inactive	Yes
28.96 Rel. 56 time ON	Relay K56 time ON	The delay ON time of relay 56. 0.00 .. 100.00 s (0.00 = without delay)	0.00s	Yes
28.97 Rel. 56 time OFF	Relay K56 time OFF	The delay OFF time of relay 56. 0.00 .. 100.00 s (0.00 = without delay)	0.00s	Yes
28.98 Rel. 56 inv	Relay K56 signal inversion	000 No 001 Yes	000 No	Yes

Parameter / Name	Function	Available options / measurement unit	Factory setting	Change during operation
Group 29 - PID				
29.01 PID 1 ref	Choice of PID 1 controller referencing unit	300 Keyboard ref. - referencing frequency by Control Panel 301 PID out 1 - referencing frequency by PID 1 output 302 PID out 2 - referencing frequency by PID 2 output 303 PID out 3 - referencing frequency by PID 3 output 304 PID out 4 - referencing frequency by PID 4 output 305 Motopot 1 - referencing frequency by motopotentiometer 1 306 Motopot 2 - referencing frequency by motopotentiometer 2 307 Motopot 3 - referencing frequency by motopotentiometer 3 308 Motopot 4 - referencing frequency by motopotentiometer 4 309 Remote ref - referencing frequency by RS connection 310 Ref An. 0 – referencing frequency by signal from analog input AI0 311 Ref An. 1 – referencing frequency by signal from analog input AI1 312 Ref An. 2 – referencing frequency by signal from analog input AI2 313 Ref An. 3 – referencing frequency by signal from analog input AI3 314 Ref An. 4 – referencing frequency by signal from analog input AI4	310 Ref An. 0	Yes
29.02 PID 1 input	Choice of regulated value of PID controller	300 Keyboard ref. - referencing frequency by Control Panel 301 PID out 1 - referencing frequency by PID 1 output 302 PID out 2 - referencing frequency by PID 2 output 303 PID out 3 - referencing frequency by PID 3 output 304 PID out 4 - referencing frequency by PID 4 output 305 Motopot 1 - referencing frequency by motopotentiometer 1 306 Motopot 2 - referencing frequency by motopotentiometer 2 307 Motopot 3 - referencing frequency by motopotentiometer 3 308 Motopot 4 - referencing frequency by motopotentiometer 4 309 Remote ref - referencing frequency by RS connection 310 Ref An. 0 – referencing frequency by signal from analog input AI0 311 Ref An. 1 – referencing frequency by signal from analog input AI1 312 Ref An. 2 – referencing frequency by signal from analog input AI2 313 Ref An. 3 – referencing frequency by signal from analog input AI3 314 Ref An. 4 – referencing frequency by signal from analog input AI4	311 Ref An. 1	Yes
29.03 PID 1 neg.	Negation of controller's error	000 No 001 Yes	000 No	Yes
29.04 PID 1 kp	Amplification of proportional element	1 .. 3000 %	100 %	Yes
29.05 PID 1 ti	Constant of time I	0.01 .. 320.00 s	1.00 s	Yes
29.06 PID 1 kd	Amplification of differential element D	0 .. 500 %	0 %	Yes
29.07 PID 1 max	Upper limitation of output value	-3200.0 .. 3200.0 %	100.0 %	Yes
29.08 PID 1 min	Lower limitation of output value	-3200.0 .. 3200.0 %	0.0 %	Yes

Parameter / Name	Function	Available options / measurement unit	Factory setting	Change during operation
29.09 PID 1 reset	Resetting PID output when device is stopped	<p>0 – reset on STOP 1 – PID controller continuously active 2 – when the PID controller is not active PID's output tracks the actual reference frequency - only for the case of direct use of the PID controller:</p> <p>par. 20.10 Ref unit A1 par. 20.20 Ref unit A2 par. 20.30 Ref unit B1 par. 20.40 Ref unit B2.</p> <p><i>Note: When the PID controller is used via PLC function blocks, this parameter should be set to 0 or 1</i></p>	0	Yes
29.11 PID 1 Sleep	Time before activating sleep function when the output remains on a minimum	0 .. 32000 s	0 s	Yes
29.12 PID 1 wakeup	A threshold of wakening from sleep state	0.0 .. 100.0%	5.0 %	Yes
29.13 PID 1 wake type	Type of wake up on sleep state	<p>0: Sleep function is disabled 1: If PID 1 output value is below min. PID 1 value (par. 29.08) for time specified in par. 29.11 then sleep mode is activated. 2: service parameter</p>	0	Yes
29.21 PID 2 ref	Choice of PID controller referencing unit	The same as par. 29.01	310 Ref An. 0	Yes
29.22 PID 2 input	Choice of regulated value of PID controller	The same as par. 29.02	311 Ref An. 1	Yes
29.23 PID 2 neg.	Negation of controller's error	000 No 001 Yes	000 No	Yes
29.24 PID 2 kp	Amplification of proportional element	1 .. 3000 %	100 %	Yes
29.25 PID 2 ti	Constant of time I	0.01 .. 320.00 s	1.00 s	Yes
29.26 PID 2 kd	Amplification of differential element D	0 .. 500 %	0 %	Yes
29.27 PID 2 max	Upper limitation of output value	-3200.0 .. 3200.0 %	100.0 %	Yes
29.28 PID 2 min	Lower limitation of output value	-3200.0 .. 3200.0 %	0.0 %	Yes
29.29 PID 2 reset	Resetting PID output when device is stopped	The same as par. 29.09	0	Yes
29.31 PID 2 Sleep	Time before activating sleep function when the output remains on a minimum	0 .. 32000 s	0 s	Yes
29.32 PID 2 wakeup	A threshold of wakening from sleep state	0.0 .. 100.0%	5.0 %	Yes
29.33 PID 2 wake type	Type of wake up on sleep state	The same as par. 29.13	0	Yes
29.41 PID 3 ref	Choice of PID controller referencing unit	The same as par. 29.01	310 Ref An. 0	Yes
29.42 PID 3 input	Choice of regulated value of PID controller	The same as par. 29.02	311 Ref An. 1	Yes
29.43 PID 3 neg.	Negation of controller's error	000 No 001 Yes	000 No	Yes
29.44 PID 3 kp	Amplification of proportional element	1 .. 3000 %	100 %	Yes
29.45 PID 3 ti	Constant of time I	0.01 .. 320.00 s	1.00 s	Yes
29.46 PID 3 kd	Amplification of differential element D	0 .. 500 %	0 %	Yes
29.47 PID 3 max	Upper limitation of output value	-3200.0 .. 3200.0 %	100.0 %	Yes
29.48 PID 3 min	Lower limitation of output value	-3200.0 .. 3200.0 %	0.0 %	Yes
29.49 PID 3 reset	Resetting PID output when device is stopped	The same as par. 29.09	0	Yes
29.51 PID 3 Sleep	Time before activating sleep function when the output remains on a minimum	0 .. 32000 s	0 s	Yes

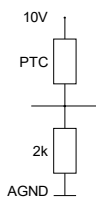
Parameter / Name	Function	Available options / measurement unit	Factory setting	Change during operation
29.52 PID 3 wakeup	A threshold of wakening from sleep state	0.0 .. 100.0%	5.0 %	Yes
29.53 PID 3 wake type	Type of wake up on sleep state	The same as par. 29.13	0	Yes
29.61 PID 4 ref	Choice of PID controller referencing unit	The same as par. 29.01	310 Ref An. 0	Yes
29.62 PID 4 input	Choice of regulated value of PID controller	The same as par. 29.02	311 Ref An. 1	Yes
29.63 PID 4 neg.	Negation of controller's error	000 No 001 Yes	000 No	Yes
29.64 PID 4 kp	Amplification of proportional element	1 .. 3000 %	100 %	Yes
29.65 PID 4 ti	Constant of time I	0.01 .. 320.00 s	1.00 s	Yes
29.66 PID 4 kd	Amplification of differential element D	0 .. 500 %	0 %	Yes
29.67 PID 4 max	Upper limitation of output value	-3200.0 .. 3200.0 %	100.0 %	Yes
29.68 PID 4 min	Lower limitation of output value	-3200.0 .. 3200.0 %	0.0 %	Yes
29.69 PID 4 reset	Resetting PID output when device is stopped	The same as par. 29.09	0	Yes
29.71 PID 4 Sleep	Time before activating sleep function when the output remains on a minimum	0 .. 32000 s	0 s	Yes
29.72 PID 4 wakeup	A threshold of wakening from sleep state	0.0 .. 3200.0 %	5.0 %	Yes
29.73 PID 4 wake type	Type of wake up on sleep state	The same as par. 29.13	0	Yes
Group 30 - Motor protect.				
30.01 Therm. fault	Response to thermistor fault	000 None - no response 001 Warning - a warning will be displayed 002 Fault - device will stop and message will be displayed	000 None	Yes
30.02 Therm. source	Thermistor source	000 Disabled – disabled 001 Input 1 .. 010 Input 10 – digital signal for thermistor 123 An. Inp 1 .. 124 An. Inp 4 - analog input for thermistor 	000 Disabled	Yes
30.10 I2T block.	Switching on blocking from thermal overload	000 No - disabled 001 Yes - enabled	001 Yes	Yes
30.11 I therm.	Setting of drive thermal protection current	0.0 .. 200.0 %	100.0 %	Yes
30.12 I therm. 0	Setting of thermorelay for stopped drive	0.0 .. 200.0 %	50.0 %	Yes
30.13 Therm. const.	Constant of el. motor heating	0 .. 200 min	2 min	Yes
30.25 Motor exist	Reaction to motor exist.	If motor current is lower than percentage of nominal motor current during specified time after start, reaction will be applied: 000 None - no response 001 Warning - a warning will be displayed 002 Fault - device will stop and message will be displayed	000 None	Yes
30.26 Motor ex. curr.	Percentage of motor nominal current	10 .. 100 %	10 %	Yes
30.27 Motor ex. time	Motor exist check time	0.1s .. 10.0 s	0.5 s	Yes
30.35 I ground	Value of leakage current at which device will be shut down	10.0 .. 100.0 %	30.0 %	Yes
30.37 Low DC	<i>Service parameter</i>	200 .. 1000 V	200 V	Yes

Parameter / Name	Function	Available options / measurement unit	Factory setting	Change during operation
30.40 Re.Sym. lack	Response to asymmetry of the load	000 None - no response 001 Warning - a warning will be displayed 002 Fault - device will stop and message will be displayed	000 None	Yes
30.45 Re. underload	Response to underload	000 None - no response 001 Warning - a warning will be displayed 002 Fault - device will stop and message will be displayed	000 None	Yes
30.46 Underl. time	Time of underload	0 .. 1200s	0 s	Yes
30.47 Underl. torque	Torque of underload	0.0 .. 100.0 %	0.0 %	Yes
30.50 Stall re.	Response to stall of the drive	000 None - no response 001 Warning - a warning will be displayed 002 Fault - device will stop and message will be displayed	000 None	Yes
30.51 Stall freq.	Stall frequency	0.0 .. 30.0 Hz	0.0 Hz	Yes
30.52 Stall time	Stall time	0 .. 600 s	0 s	Yes
30.60 Speed err re.	Response to error of output speed	000 None - no response 001 Warning - a warning will be displayed 002 Fault - device will stop and message will be displayed	000 None	Yes
30.61 Delta n-nz	Acceptable difference between referenced speed and speed of the el. motor.	0 .. 500 rpm	0 rpm	Yes
30.62 D time max.	Maximum time of acceptable error	0.0 .. 12.0 s	0.0 s	Yes
30.70 Motor overcurr.	Motor overcurrent additional protection.	After specified time in 30.71 and if motor current is higher than this parameter, fault occurs. 100 .. 250 %	220%	Yes
30.71 Motor overcurr. t	Motor overcurrent time.	0 .. 20 ms If time equals 0, fault is disabled	5ms	Yes
Group 31 - External faults				
31.00 exFault 0 in A	Choice of external fault 0 source A	000 Disabled - disabled 001 Input 1 .. 010 Input 10 - reporting external fault 1, when there is a voltage supplied on digital input DI1 .. DI10	000 Disabled	Yes
31.01 exFault 0 in B	Choice of external fault 0 source B	000 Disabled - disabled 001 Input 1 .. 010 Input 10 - reporting external fault 1, when there is a voltage supplied on digital input DI1 .. DI10	000 Disabled	Yes
31.02 exFault 0 config	External fault configuration	000 - Disabled 001 - "A" AND "B" 002 - "A" OR "B" 003 - "A" XOR "B" 004 - "NOT A" AND "B"	000 Disabled	Yes
31.03 exFault 0 delay	Delay between occurring fault signal and activating fault status	0.00 .. 320.00 s	1.00 s	Yes
31.04 Fault text 0	Fault text (see group 44)	0 .. 49	0	Yes
31.05 .. 31.99	The same as above			
Group 32 - Analog inputs: response to lack of signal				
32.01 Sw.on AI	Reporting failure of lack of signal (<2V) on analog inputs AI0, AI1, ..., AI52 when this input doesn't use as referencing-unit	000 Disabled - don't report failures 001 Input 1 .. 010 Input 10 - reporting failures, when there is voltage supplied on digital input DI1..DI10 531 Enabled - always report failures	000 Disabled	Yes
32.02 Re.4mA err 0	Response to lack of signal on analog input AI0: signal level is lower than 2V or 4mA – depends on settings in group 24	000 None - no response 001 Warning - a warning will be displayed 002 Fault - device will stop and message will be displayed 003 Last freq. - a warning will be displayed, frequency will stay on an average level from last 10 seconds 004 Const freq. 15 - device will work with referenced frequency f const. 15	000 None	Yes
32.03 Re.4mA err 1	AI1 - as in par. 32.02	as above	as above	as above

Parameter / Name	Function	Available options / measurement unit	Factory setting	Change during operation
32.04 Re.4mA err 2	AI2 - as in par. 32.02	as above	as above	as above
32.05 Re.4mA err 3	AI3 - as in par. 32.02	as above	as above	as above
32.06 Re.4mA err 4	AI4 - as in par. 32.02	as above	as above	as above
32.10 Re.4mA err 11	AI11 - as in par. 32.02	as above	as above	as above
32.11 Re.4mA err 12	AI12 - as in par. 32.02	as above	as above	as above
32.12 Re.4mA err 21	AI21 - as in par. 32.02	as above	as above	as above
32.13 Re.4mA err 22	AI22 - as in par. 32.02	as above	as xtve	as above
32.14 Re.4mA err 31	AI31 - as in par. 32.02	as above	as above	as above
32.15 Re.4mA err 32	AI32 - as in par. 32.02	as above	as above	as above
32.16 Re.4mA err 41	AI41 - as in par. 32.02	as above	as above	as above
32.17 Re.4mA err 42	AI42 - as in par. 32.02	as above	as above	as above
32.18 Re.4mA err 51	AI51 - as in par. 32.02	as above	as above	as above
32.19 Re.4mA err 52	AI52 - as in par. 32.02	as above	as above	as above
Group 33 - Communic. man.				
33.10 AcR fail. Re	Reaction to lack of communication with AcR module or failure AcR device	001 Warning - a warning will be displayed, device keeps working with set frequency 002 Fault - device will stop and message will be displayed	002 Fault	Yes
33.11 Re. RS lack	Response to lack of communication through RS link	000 None - no response 001 Warning - a warning will be displayed 002 Fault - device will stop and message will be displayed 003 Last freq. - a warning will be displayed, frequency will stay on an average level from last 10s 004 Const freq. 15 - device will work with referenced frequency f const. 15	000 None	Yes
33.12 Rs lack	Acceptable time of lack of communication through RS link	0 .. 600 s	30 s	Yes
33.50 Re. key lack	Response to lack of keyboard (only for referencing from keyboard)	The same as par. 33.11	000 None	Yes
33.51 Key lack time	Acceptable time of lack of keyboard	0 .. 300 s	30 s	Yes
Group 34 - Other man.				
34.01 R breaking t	Maximum operate resistor's time in DC voltage	0.00 .. 650.00 s	5.00 s	Yes
34.02 Re. Rbrake	Reaction to the excess braking time	000 None - no response 001 Warning - a warning will be displayed 002 Fault - device will stop and message will be displayed	001 Warning	Yes
34.03 R break power	Power of breaking resistors	0.00 - 650.00 kW	0	Yes
34.04 R break resis	Resistance of breaking resistors	0.00 - 650.00 ohm	0	Yes
34.05 R break NO RUN	Breake resistor active during STOP	PCH.0 .. PCH.999	PCH 531	No
Group 35 Autorestarts				
35.01 Rest. max count	Max number of automatic restarts	0 - no restarts 1 ... 6 – number of restarts in time determined by par 35.02	0	YES
35.02 Rest. time	Time of restarts	0 ... 1200.0 s	60 s	YES
35.03 Rest. delay	Restart delay	0.0 ... 10.0 s	1.0 s	YES
35.04 Rest. low dc	Automatic restart after Low Udc failure	NO - no restart YES - permission	NO	YES
35.05 Rest. high dc	Automatic restart after High Udc failure	NO - no restart YES - permission	NO	YES
35.06 Rest. high curr	Automatic restart after High Current failure	NO - no restart YES - permission	NO	YES
35.07 Rest. high temp	Automatic restart after High temperature of the heatsink failure	NO - no restart YES – permission	NO	YES

Parameter / Name	Function	Available options / measurement unit	Factory setting	Change during operation
35.08 Rest. analog in.	Automatic restart after failure Analog input error	NO - no restart YES - permission	NO	YES
35.09 Rest. others	Automatic restart after failures other than par. 35.04-35.07	NO - no restart YES - permission	NO	YES
Group 40 Unit control				
40.01 Par. block	Parameters blocking	000 No : modification of parameters is unblocked 001 Yes : modification of parameters is blocked	000 No	Yes
40.02	ModBus login	Parameter reserved for logging in via the ModBus protocol. Note: The parameter is not available from the OP-11 operator panel	-	-
40.03 Language	Language of the Control Panel	000 English 001 Polish	000 English	Yes
40.04 Default param.	Load default parameters	1	1	No
40.05 Enable EEPROM	Access to save changes in EEPROM memory	000 No : Switching on blocking of writing to EEPROM memory (parameters can be changed, however they won't be remembered after shut down of power) 001 Yes : parameters are normally written to EEPROM (the access level Lvl2 is necessary)	001 Yes	Yes
40.06 Full PCH	Full list of Characteristic Points (PCH) are available	000 No 001 Yes : values of parameters which are pointers (e.g. par. 40.07) are possible to change in full range PCH.000...PCH.999	000 No	Yes
40.07 Enable RS	Permission to control converter through RS communication: e.g. Start/Stop	000 Denied 001 Input 1 .. 010 Input 10 531 Allowed Note: without this permission you can connect with the frequency inverter and read/save parameters, but you cannot control the drive	531 Allowed	Yes
40.11 Unit number	Identification number of device	1 .. 247	12	Yes
40.16 Level 1 Code	The code for access level 1	Changing the code to access level 1. Prior login to access level 1 is required. Read-only parameter.	-	Yes
40.17 Level 2 Code	The code for access level 2	Changing the code to access level 2. Prior login to access level 2 is required. Read-only parameter.	-	Yes
40.18 Level 3 Code	The code for access level 3	Changing the code to access level 3. Prior login to access level 3 is required. Read-only parameter.	-	Yes
Group 41				
41.00 Scr. 1 number	<i>Service parameter</i>	1 .. 4	3	Yes
41.01 Scr. 2 number	<i>Service parameter</i>	1 .. 4	3	
41.02 Scr. 3 number	<i>Service parameter</i>	1 .. 4	3	
41.10 1.1 start type	<i>Service parameter</i>	0	0	
41.11 1.1 start	<i>Service parameter</i>	All parameters from group <i>Monitor</i>	00.03F out	
41.12 1.2 start type	<i>Service parameter</i>	0	0	
41.13 1.2 start	<i>Service parameter</i>	All parameters from group <i>Monitor</i>	00.06Motor curr	
41.14 1.3 start type	<i>Service parameter</i>	0	0	
41.15 1.3 start	<i>Service parameter</i>	All parameters from group <i>Monitor</i>	00.05Mot torque	
41.16 1.4 start type	<i>Service parameter</i>	0	0	
41.17 1.4 start	<i>Service parameter</i>	All parameters from group <i>Monitor</i>	00.00	
41.18 1.1 stop type	<i>Service parameter</i>	0	0	
41.19 1.1 stop	<i>Service parameter</i>	All parameters from group <i>Monitor</i>	000.03F out	
41.20 1.2 stop type	<i>Service parameter</i>	0	0	
41.21 1.2 stop	<i>Service parameter</i>	All parameters from group <i>Monitor</i>	00.06Motor curr	
41.22 1.3 stop type	<i>Service parameter</i>	0	0	
41.23 1.3 stop	<i>Service parameter</i>	All parameters from group <i>Monitor</i>	00.05Mot torque	
41.24 1.4 stop type	<i>Service parameter</i>	0	0	
41.25 1.4 stop	<i>Service parameter</i>	All parameters from group <i>Monitor</i>	00.00	
41.30 2.1 type	<i>Service parameter</i>	0	0	

Parameter / Name	Function	Available options / measurement unit	Factory setting	Change during operation
41.31 2.1	Service parameter	All parameters from group <i>Monitor</i>	00.13la curr.	
41.32 2.2 type	Service parameter	0	0	
41.33 2.2	Service parameter	All parameters from group <i>Monitor</i>	00.14lb curr	
41.34 2.3 type	Service parameter	0	0	
41.35 2.3	Service parameter	All parameters from group <i>Monitor</i>	00.15lc curr	
41.36 2.4 type	Service parameter	0	0	
41.37 2.4	Service parameter	All parameters from group <i>Monitor</i>	00.00	
41.40 3.1 type	Service parameter	0	0	
41.41 3.1	Service parameter	All parameters from group <i>Monitor</i>	01.01Motor n	
41.42 3.2 type	Service parameter	0	0	
41.43 3.2	Service parameter	All parameters from group <i>Monitor</i>	01.05Mot torque	
41.44 3.3 type	Service parameter	0	0	
41.45 3.3	Service parameter	All parameters from group <i>Monitor</i>	01.09Output power	
41.46 3.4 type	Service parameter	0	0	
41.47 3.4	Service parameter	All parameters from group <i>Monitor</i>	00.00	
41.50 Down left	Service parameter	All parameters from group <i>Monitor</i>	00.03F out	
41.51 Down right	Service parameter	All parameters from group <i>Monitor</i>	00.05Mot torque	
Group 42 – User parameters				
42.01 Nproc scale	Scale of Process N	Multiplier of speed displayed as parameter 00.00 N process 0.0 .. 500.0 %	100 %	Yes
42.02 Nproc unit	Process N unit	001 V, 002 A, 003 Hz, 004 rpm, 005 %, 006 Ohm, 007 kHz, 008 °C, 009 kW, 010 Nm, 011 kWh, 012 mH, 013 s 014 h, 015 ms, 016 mOhm, 017 m/s 018 pcs, 019 imp, 020 Hpa, 023 Bar 022 m, 023 mm, 024 m/m, 025 Wb 026 MWh, 027 kVar, 028 min, 029 mA	005 %	Yes
42.03 Nproc decimal	Number of decimal places of Process N	Number of decimal places for par. 00.00 0 ... 3	1	Yes
42.10 Rot scale	Scale of rotation counter	Number of units that correspond to one encoder rotation 0 .. 32000	1	Yes
42.11 Rot reset	Resetting rotation counter	0 .. 999	000 Disabled	Yes
42.20 User par adr 1	User unit 1 source	0 .. 999	000 Disabled	Yes
42.21 User par unit 1	User unit 1	See par. 42.02	005 %	Yes
42.22 User par dec 1	User unit 1 decimal place	0,1,2,3	1	Yes
42.23 User par text 1	User unit 1 text	0 .. 49	0	Yes
42.24 .. 42.99	as above			
Group 43 – User reference				
43.01 Ref user	Service parameter	0 .. 10	0	Yes
43.02 User ref number	Number of user references	0 .. 10	0	Yes
43.10 Reference 1	Reference value	-32000 .. 32000	0	Yes
43.11 Ref min 1	Reference minimum value	-5000 .. 5000	0	Yes
43.12 Ref max 1	Reference maximum value	-5000 .. 5000	1000	Yes
43.13 Ref unit 1	Reference unit	001 V, 002 A, 003 Hz, 004 rpm, 005 %, 006 Ohm, 007 kHz, 008 °C, 009 kW, 010 Nm, 011 kWh, 012 mH, 013 s 014 h, 015 ms, 016 mOhm, 017 m/s 018 pcs, 019 imp, 020 Hpa, 023 Bar 022 m, 023 mm, 024 m/m, 025 Wb 026 MWh, 027 kVar, 028 min, 029 mA	005%	Yes
43.14 Ref dec 1	Reference decimal	0 ... 3	1	Yes
43.15 Ref text 1	Reference text (see group 44)	0 ... 49	0	Yes
43.16 .. 43.69	As above			
Group 44 – User text				
44.01 User text 0	User text	Editable text with 20 sings		Yes

Parameter / Name	Function	Available options / measurement unit	Factory setting	Change during operation
44.02 .. 44.50 User text 1 .. 49	As above			
Group 45 - Communication canal 1				
45.01 Protocol	Protocol selection	0 Modbus RTU - RS-485 1 Modbus RTU Master - RS-485	0	Yes
Modbus RTU (CH1) communication parameters				
45.02 Speed	Transmission speed	000 2400 001 4800 002 9600 003 19200 004 38400 005 57600 006 115200	002 9600	Yes
45.03 Parity	Parity	0, 1	0	Yes
45.04 Stop bits	Stop bits	0, 1	0	Yes
45.05 Terminator	Terminator	0, 1	0	Yes
45.06 Timeout	Timeout	0 .. 600 s	30 s	Yes
45.07 Tout react	Reaction to the lack of RS-485 communication	000 None - no response 001 Warning - a warning will be displayed, device will keep working with referenced frequency 002 Fault - device will stop and message will be displayed 003 Last freq. - a warning will be displayed, frequency will stay on an average level from last 10s 004 Const freq. 15 - device will work with referenced frequency f const. 15	000 None	Yes
Group 46 - Communication canal 2				
46.01 Protocol	Protocol selection	0 Modbus RTU - RS-485 1 Modbus RTU Master - RS-485 2 CAN	0	Yes
Modbus RTU (CH2) communication parameters				
46.02 Speed	Transmission speed	000 2400 001 4800 002 9600 003 19200 004 38400 005 57600 006 115200	002 9600	Yes
46.03 Parity	Parity	0, 1	0	Yes
46.04 Stop bits	Stop bits	0, 1	0	Yes
46.05 Terminator	Terminator	0, 1	0	Yes
46.06 Timeout	Timeout	0 .. 600 s	30 s	Yes
46.07 Tout react	Reaction to the lack of RS-485 communication	000 None - no response 001 Warning - a warning will be displayed, device will keep working with referenced frequency 002 Fault - device will stop and message will be displayed 003 Last freq. - a warning will be displayed, frequency will stay on an average level from last 10s 004 Const freq. 15 - device will work with referenced frequency f const. 15	000 None	Yes
CAN (CH2) communication parameters				
46.06 Timeout	RxPDO1 Timeout	0 .. 600 s	30 s	Yes
46.07 Tout react	Response to lack of communication through CAN Module (RxPDO1 Timeout, Heartbeat Timeout)	000 None - no response 001 Warning - a warning will be displayed, device keeps working with referenced frequency f const. 7 002 Fault - device will stop and message will be displayed 003 Last freq. - a warning will be displayed, frequency will stay on an average level from last 10s 004 Const freq. 15 - device will work with referenced frequency f const. 15	000 None	Yes
46.10	CAN ID	1..127	12	Yes ¹⁾
46.11	CAN Speed	000 50 kbit 001 100kbit 002 125 kbit 003 250 kbit 004 500 kbit 005 1000 kbit	004 500 kbit	Yes ¹⁾
46.12	CAN Profile	000 CiA 402 001..011 USER1	000 CiA 402	Yes ¹⁾
46.13	HeartBeat Procuer Time	0..32000 ms	0	Yes ¹⁾
46.14	HearBeat Consumer Node	1...127	0	Yes ¹⁾

1) The frequency converter must be restarted

Parameter / Name	Function	Available options / measurement unit	Factory setting	Change during operation
46.15	HeartBeat Consumer Time	1...32000 ms	0	Yes ¹⁾
PDO1				
46.20	Rx PDO1 COB-ID	0 .. 1407 (0x0 .. 0x57F)	0x200	Yes ¹⁾
46.21	Rx PDO1 Type	0 .. 255	254	Yes ¹⁾
46.24	Rx PDO1 Active	0,1 0=inactive 1=active	1	Yes ¹⁾
46.25	Tx PDO1 COB-ID	0 .. 1407 (0x0 .. 0x57F)	0x180	Yes ¹⁾
46.26	Tx PDO1 Type	0 .. 255	254	Yes ¹⁾
46.27	Tx PDO1 Event Time	0 .. 65535 ms	0 ms	Yes ¹⁾
46.28	Tx PDO1 Inhibit Time	0.0.. 6553.5 ms, only for RTR	0.0 ms	Yes ¹⁾
46.29	Tx PDO1 Active / RTR	0,1,2,3 where: 0=00, 1=01, 2=10, 3=11 bit 0: 1=active 0=inactive bit 1: 1=RTR allowed 0=RTR no allowed	3	Yes ¹⁾
PDO2				
46.30	Rx PDO2 COB-ID	0 .. 1407 (0x0 .. 0x57F)	0x300	Yes ¹⁾
46.31	Rx PDO2 Type	0 .. 255	254	Yes ¹⁾
46.34	Rx PDO2 Active	0,1 0=inactive 1=active	1	Yes ¹⁾
46.35	Tx PDO2 COB-ID	0 .. 1407 (0x0 .. 0x57F)	0x280	Yes ¹⁾
46.36	Tx PDO2 Type	0 .. 255	254	Yes ¹⁾
46.37	Tx PDO2 Event Time	0 .. 65535 ms	0 ms	Yes ¹⁾
46.38	Tx PDO2 Inhibit Time	0.0.. 6553.5 ms	0.0 ms	Yes ¹⁾
46.39	Tx PDO2 Active / RTR	0,1,2,3 where: 0=00, 1=01, 2=10, 3=11 bit 0: 1=active 0=inactive bit 1: 1=RTR allowed 0=RTR no allowed	3	Yes ¹⁾
PDO3				
46.40	Rx PDO3 COB-ID	0 .. 1407 (0x0 .. 0x57F)	0x400	Yes ¹⁾
46.41	Rx PDO3 Type	0 .. 255	254	Yes ¹⁾
46.44	Rx PDO3 Active	0,1 0=inactive 1=active	1	Yes ¹⁾
46.45	Tx PDO3 COB-ID	0 .. 1407 (0x0 .. 0x57F)	0x380	Yes ¹⁾
46.46	Tx PDO3 Type	0 .. 255	254	Yes ¹⁾
46.47	Tx PDO3 Event Time	0 .. 65535 ms	0 ms	Yes ¹⁾
46.48	Tx PDO3 Inhibit Time	0.0.. 6553.5 ms	0.0 ms	Yes ¹⁾
46.49	Tx PDO3 Active / RTR	0,1,2,3 where: 0=00, 1=01, 2=10, 3=11 bit 0: 1=active 0=inactive bit 1: 1=RTR allowed 0=RTR no allowed	3	Yes ¹⁾
PDO4				
46.50	Rx PDO4 COB-ID	0 .. 1407 (0x0 .. 0x57F)	0x500	Yes ¹⁾
46.51	Rx PDO4 Type	0 .. 255	254	Yes ¹⁾
46.54	Rx PDO4 Active	0, 1 0=nieaktywne, 1=aktywne	1	Yes ¹⁾
46.55	Tx PDO4 COB-ID	0 .. 1407 (0x0 .. 0x57F)	0x480	Yes ¹⁾
46.56	Tx PDO4 Type	0 .. 255	254	Yes ¹⁾
46.57	Tx PDO4 Event Time	0 .. 65535 ms	0 ms	Yes ¹⁾
46.58	Tx PDO4 Inhibit Time	0.0.. 6553.5 ms	0.0 ms	Yes ¹⁾
46.59	Tx PDO4 Active / RTR	0,1,2,3 where: 0=00, 1=01, 2=10, 3=11 bit 0: 1=active 0=inactive bit 1: 1=RTR allowed 0=RTR no allowed	3	Yes ¹⁾
Group 47 - Communication canal 3				
47.01 Protocol	Protocol selection	0 Modbus RTU - RS-485 1 Modbus RTU Master - RS-485 2 Modbus TCP - Ethernet	0	Yes

Parameter / Name	Function	Available options / measurement unit	Factory setting	Change during operation
Modbus RTU (CH3) communication parameters				
47.02 Speed	Transmission speed	000 2400 002 9600 004 38400 006 115200 001 4800 003 19200 005 57600	002 9600	Yes
47.03 Parity	Parity	0, 1	0	Yes
47.04 Stop bits	Stop bits	0, 1	0	Yes
47.05 Terminator	Terminator	0, 1	0	Yes
47.06 Timeout	Timeout	0 .. 600 s	30 s	Yes
47.07 Tout react	Reaction to the lack of RS-485 communication	000 None - no response 001 Warning - a warning will be displayed, device will keep working with referenced frequency 002 Fault - device will stop and message will be displayed 003 Last freq. - a warning will be displayed, frequency will stay on an average level from last 10s 004 Const freq. 15 - device will work with referenced frequency f const. 15	000 None	Yes
Modbus TCP (CH3) communication parameters				
47.10 ETH IP 1	First part of IP address	0 .. 255, example: 192 .168.1.50	192	Yes
47.11 ETH IP 2	Second part of IP addr.	0 .. 255, example: 192. 168 .1.50	168	Yes
47.12 ETH IP 3	Third part of IP address	0 .. 255, example: 192.168. 1 .50	1	Yes
47.13 ETH IP 4	Fourth part of IP address	0 .. 255, example: 192.168.1.. 2		Yes
47.14 ETH MASK 1	First part of mask address	0 .. 255, example: 255 .255.255.0	255	Yes
47.15 ETH MASK 2	Second part of mask address	0 .. 255, example: 255. 255 .255.0	255	Yes
47.16 ETH MASK 3	Third part of mask address	0 .. 255, example: 255.255. 255 .0	255	Yes
47.17 ETH MASK 4	Fourth part of mask address	0 .. 255, example: 255.255.255. 0	0	Yes
47.18 ETH GW 1	First part of gateway address	0 .. 255, example: 192 .168.1.1	192	Yes
47.19 ETH GW 2	Second part of gateway address	0 .. 255, example: 192. 168 .1.1	168	Yes
47.20 ETH GW 3	Third part of gateway address	0 .. 255, example: 192.168. 1 .1	1	Yes
47.21 ETH GW 4	Fourth part of gateway address	0 .. 255, example: 192.168.1. 1	1	Yes
47.22 ETH port	Ethernet port	0 .. 65535	502	Yes
47.23 ETH dhcp	Ethernet DHCP	0: No 1: Yes	No	Yes
47.24 ETH timeout	TCP connection timeout	0 .. 600 s	10 s	Yes
Group 49 – Parameter mapping				
49.00 Fast Read1	<i>Selection of the variable assigned to ACTR1</i>	<i>All parameters and PCH</i>	PCH770	Yes
49.01 Fast Read2	<i>Selection of the variable assigned to ACTR2</i>	<i>All parameters and PCH</i>	PCH771	Yes
49.02 Fast Read3	<i>Selection of the variable assigned to ACTR3</i>	<i>All parameters and PCH</i>	PCH772	Yes
49.03 Fast Read4	<i>Selection of the variable assigned to ACTR4</i>	<i>All parameters and PCH</i>	PCH773	Yes
49.04 Fast Read5	<i>Selection of the variable assigned to ACTR5</i>	<i>All parameters and PCH</i>	PCH774	Yes
49.05 Fast Read6	<i>Selection of the variable assigned to ACTR6</i>	<i>All parameters and PCH</i>	PCH775	Yes
49.06 Fast Read7	<i>Selection of the variable assigned to ACTR7</i>	<i>All parameters and PCH</i>	PCH776	Yes
49.07 Fast Read8	<i>Selection of the variable assigned to ACTR8</i>	<i>All parameters and PCH</i>	PCH777	Yes
49.08 Fast Read9	<i>Selection of the variable assigned to ACTR9</i>	<i>All parameters and PCH</i>	PCH778	Yes
49.09 Fast Read10	<i>Selection of the variable assigned to ACTR10</i>	<i>All parameters and PCH</i>	PCH779	Yes
49.10 Fast Read11	<i>Selection of the variable assigned to ACTR11</i>	<i>All parameters and PCH</i>	PCH780	Yes
49.11 Fast Read12	<i>Selection of the variable assigned to ACTR12</i>	<i>All parameters and PCH</i>	PCH781	Yes

Parameter / Name	Function	Available options / measurement unit	Factory setting	Change during operation
49.12 Fast Read13	Selection of the variable assigned to ACTR13	All parameters and PCH	PCH782	Yes
49.13 Fast Read14	Selection of the variable assigned to ACTR14	All parameters and PCH	PCH783	Yes
49.14 Fast Read15	Selection of the variable assigned to ACTR15	All parameters and PCH	PCH784	Yes
49.15 Fast Read16	Selection of the variable assigned to ACTR16	All parameters and PCH	PCH785	Yes
49.16 Fast Read17	Selection of the variable assigned to ACTR17	All parameters and PCH	PCH786	Yes
49.17 Fast Read18	Selection of the variable assigned to ACTR18	All parameters and PCH	PCH787	Yes
49.18 Fast Read19	Selection of the variable assigned to ACTR19	All parameters and PCH	PCH788	Yes
49.19 Fast Read20	Selection of the variable assigned to ACTR20	All parameters and PCH	PCH789	Yes
49.20 Fast write1	Selection of the variable assigned to ACTW01	All parameters and PCH	PCH750	Yes
49.21 Fast write2	Selection of the variable assigned to ACTW02	All parameters and PCH	PCH751	Yes
49.22 Fast write3	Selection of the variable assigned to ACTW03	All parameters and PCH	PCH752	Yes
49.23 Fast write4	Selection of the variable assigned to ACTW04	All parameters and PCH	PCH753	Yes
49.24 Fast write5	Selection of the variable assigned to ACTW05	All parameters and PCH	PCH754	Yes
49.25 Fast write6	Selection of the variable assigned to ACTW06	All parameters and PCH	PCH755	Yes
49.26 Fast write7	Selection of the variable assigned to ACTW07	All parameters and PCH	PCH756	Yes
49.27 Fast write8	Selection of the variable assigned to ACTW08	All parameters and PCH	PCH757	Yes
49.28 Fast write9	Selection of the variable assigned to ACTW09	All parameters and PCH	PCH758	Yes
49.29 Fast write10	Selection of the variable assigned to ACTW010	All parameters and PCH	PCH759	Yes
49.30 Fast write11	Selection of the variable assigned to ACTW011	All parameters and PCH	PCH760	Yes
49.31 Fast write12	Selection of the variable assigned to ACTW012	All parameters and PCH	PCH761	Yes
49.32 Fast write13	Selection of the variable assigned to ACTW013	All parameters and PCH	PCH762	Yes
49.33 Fast write14	Selection of the variable assigned to ACTW014	All parameters and PCH	PCH763	Yes
49.34 Fast write15	Selection of the variable assigned to ACTW015	All parameters and PCH	PCH764	Yes
49.35 Fast write16	Selection of the variable assigned to ACTW016	All parameters and PCH	PCH765	Yes
49.36 Fast write17	Selection of the variable assigned to ACTW017	All parameters and PCH	PCH766	Yes
49.37 Fast write18	Selection of the variable assigned to ACTW018	All parameters and PCH	PCH767	Yes
49.38 Fast write19	Selection of the variable assigned to ACTW019	All parameters and PCH	PCH768	Yes
49.39 Fast write20	Selection of the variable assigned to ACTW020	All parameters and PCH	PCH769	Yes
Group 70 – Timers				
70.00 Timer 1 Enable	Timer 1 enable	When PCH value is different then zero, timer is enabled	000 disabled	Yes
70.01 Timer 1 Reset	Timer 1 Reset	When user set value to YES, timer is reset.	No	Yes
70.02 Timer 2 Enable	Timer 2 enable	The same as par. 70.00	000 disabled	Yes
70.03 Timer 2 Reset	Timer 2 Reset	The same as par. 70.01	No	Yes
70.04 Timer 3 Enable	Timer 3 enable	The same as par. 70.00	000 disabled	Yes
70.05 Timer 3Reset	Timer 3 Reset	The same as par. 70.01	No	Yes
70.06 Timer 4 Enable	Timer 4 enable	The same as par. 70.00	000 disabled	Yes
70.07 Timer 4Reset	Timer 4 Reset	The same as par. 70.01	No	Yes
70.08 Timer 5 Enable	Timer 5 enable	The same as par. 70.00	000 disabled	Yes
70.09 Timer 5 Reset	Timer 5 Reset	The same as par. 70.01	No	Yes

Parameter / Name	Function	Available options / measurement unit	Factory setting	Change during operation
Group 71 – PLC: Additional features				
71.01 Sw. Seq ON	Enable Sequencer	Signal of enabling PLC sequencer block PCH.0 .. PCH.999	PCH.0 (SEQ disabled)	YES
71.03 Seq max	Number of sequencer states	2 .. 8	8	YES
71.04 Seq time 1	Time of 1st state duration	PCH.0 .. PCH.999	PCH.570 (Constant 1)	YES
71.05 Seq time 2	Time of 2nd state duration	PCH.0 .. PCH.999	PCH.571 (Constant 2)	YES
71.06 Seq time 3	Time of 3rd state duration	PCH.0 .. PCH.999	PCH.572 (Constant 3)	YES
71.07 Seq time 4	Time of 4th state duration	PCH.0 .. PCH.999	PCH.573 (Constant 4)	YES
71.08 Seq time 5	Time of 5th state duration	PCH.0 .. PCH.999	PCH.574 (Constant 5)	YES
71.09 Seq time 6	Time of 6th state duration	PCH.0 .. PCH.999	PCH.575 (Constant 6)	YES
71.10 Seq time 7	Time of 7th state duration	PCH.0 .. PCH.999	PCH.576 (Constant 7)	YES
71.11 Seq time 8	Time of 8th state duration	PCH.0 .. PCH.999	PCH.577 (Constant 8)	YES
71.12 Seq Nxt	Source of "next state" signal	PCH.0 .. PCH.999	PCH.0 (disabled)	YES
71.13 Seq Prv	Source of "previous state" signal	PCH.0 .. PCH.999	PCH.0 (disabled)	YES
71.14 Seq Clr	Source of "sequencer restart" signal	PCH.0 .. PCH.999	PCH.0 (disabled)	YES
71.15 Seq Set	Source of "sequencer setting" signal	PCH.0 .. PCH.999	PCH.0 (disabled)	YES
71.16 Seq SV	Sequence to which sequencer block will be set after "Seq Set" signal	PCH.0 ... PCH.999	PCH.0 (value 0 = sequencer 0)	YES
71.21 En. Mux1	Signal of switching on MUX1 PLC block	PCH.0 .. PCH.999	PCH.0 (MUX1 disabled.)	YES
71.23 Mux1 DV	Value of MUX1 output (PCH.840) when MUX1 is disabled (par 71.21)	-32000 .. 32000	0	YES
71.24 Mux1 Sel	Source of MUX1 input selection	PCH.0 .. PCH.999	PCH.0	YES
71.25 Mux1 In.1	Value of input 1 MUX1	PCH.0 .. PCH.999	PCH.0 (= 0)	YES
71.26 Mux1 In.2	Value of input 2 MUX1	PCH.0 .. PCH.999	PCH.0 (= 0)	YES
71.27 Mux1 In.3	Value of input 3 MUX1	PCH.0 .. PCH.999	PCH.0 (= 0)	YES
71.28 Mux1 In.4	Value of input 4 MUX1	PCH.0 .. PCH.999	PCH.0 (= 0)	YES
71.29 Mux1 In.5	Value of input 5 MUX1	PCH.0 .. PCH.999	PCH.0 (= 0)	YES
71.30 Mux1 In.6	Value of input 6 MUX1	PCH.0 .. PCH.999	PCH.0 (= 0)	YES
71.31 Mux1 In.7	Value of input 7 MUX1	PCH.0 .. PCH.999	PCH.0 (= 0)	YES
71.32 Mux1 In.8	Value of input 8 MUX1	PCH.0 .. PCH.999	PCH.0 (= 0)	YES
71.41 En. Mux2	Signal of switching on MUX2 PLC block	PCH.0 .. PCH.999	PCH.0 (MUX2 disabled.)	YES
71.43 Mux2 DV	Value of MUX2 output (PCH.841) when MUX2 is disabled (par 71.41)	-32000 .. 32000	0	YES
71.44 Mux2 Sel	Source of MUX2 input selection	PCH.0 .. PCH.999	PCH.0	YES
71.45 Mux2 In.1	Value of input 1 MUX2	PCH.0 .. PCH.999	PCH.0 (= 0)	YES
71.46 Mux2 In.2	Value of input 2 MUX2	PCH.0 .. PCH.999	PCH.0 (= 0)	YES
71.47 Mux2 In.3	Value of input 3 MUX2	PCH.0 .. PCH.999	PCH.0 (= 0)	YES
71.48 Mux2 In.4	Value of input 4 MUX2	PCH.0 .. PCH.999	PCH.0 (= 0)	YES
71.49 Mux2 In.5	Value of input 5 MUX2	PCH.0 .. PCH.999	PCH.0 (= 0)	YES
71.50 Mux2 In.6	Value of input 6 MUX2	PCH.0 .. PCH.999	PCH.0 (= 0)	YES
71.51 Mux2 In.7	Value of input 7 MUX2	PCH.0 .. PCH.999	PCH.0 (= 0)	YES
71.52 Mux2 In.8	Value of input 8 MUX2	PCH.0 .. PCH.999	PCH.0 (= 0)	YES
71.62 CSU In.	CSU Input (X)	PCH.0 .. PCH.999 (PCH.0 = disabled)	PCH.0	YES
71.63 CSU X1	Point 1, value X	-32000 .. 32000	0	YES
71.64 CSU Y1	Point 1, value Y	-32000 .. 32000	0	YES
71.65 CSU X2	Point 2, value X	-32000 .. 32000	0	YES
71.66 CSU Y2	Point 2, value Y	-32000 .. 32000	0	YES
71.67 CSU X3	Point 3, value X	-32000 .. 32000	0	YES

Parameter / Name	Function	Available options / measurement unit	Factory setting	Change during operation
71.68 CSU Y3	Point 3, value Y	-32000 .. 32000	0	YES
71.69 CSU X4	Point 4, value X	-32000 .. 32000	0	YES
71.70 CSU Y4	Point 4, value Y	-32000 .. 32000	0	YES
71.71 CSU X5	Point 5, value X	-32000 .. 32000	0	YES
71.72 CSU Y5	Point 5, value Y	-32000 .. 32000	0	YES
Group 75 – PLC: Constants				
75.01 Const 1	CONSTANT 1	-32000 ... 32000. Copied to PCH.570	0	Yes
...				
75.30 Const 30	CONSTANT 30	-32000 ... 32000. Copied to PCH.599	0	Yes
Group 80 – PLC: Control				
80.01 PLC enable	Enable built-in PLC	000 No 001 Yes	000 No	No
80.02 PLC blocks no.	Number of blocks	Number of block executed by PLC 0 .. 48	0	No
Group 81 – PLC: Functional blocks 1 - 20				
81.00 Block no.1	Function of block 1	0 .. 49	0	No
81.01 Inp.A.1	Input A of block 1	All Characteristic Points (PCH)	000 Disabled	No
81.02 Inp.B.1	Input B of block 1	All Characteristic Points (PCH)	000 Disabled	No
81.03 Inp.C.1	Input C of block 1	All Characteristic Points (PCH)	000 Disabled	No
81.04 Inp.D.1	Input D of block 1	All Characteristic Points (PCH)	000 Disabled	No
81.05 Block no.2	Function of block 2	0 .. 49	0	No
81.06 Inp.A.2	Input A of block 2	All Characteristic Points (PCH)	000 Disabled	No
81.07 Inp.B.2	Input B of block 2	All Characteristic Points (PCH)	000 Disabled	No
81.08 Inp.C.2	Input C of block 2	All Characteristic Points (PCH)	000 Disabled	No
81.09 Inp.D.2	Input D of block 2	All Characteristic Points (PCH)	000 Disabled	No
81.10 - 81.99 Blocks no. 3 - 20	as above			
Group 82 – PLC: Functional blocks 23-40				
82.00 - 82.00 Blocks no. 23 - 40	as the previous blocks			
Group 83 – PLC: Functional blocks 41-60				
83.00 - 83.99 Blocks no. 41 - 60	as the previous blocks			
Group 84 – PLC: Functional blocks 61-80				
84.00 - 84.99 Blocks no. 61 - 80	as the previous blocks			
Group 85 – PLC: Functional blocks 81-100				
85.00 - 85.99 Blocks no. 81 - 100	as the previous blocks			
Group 90 - Faults				
90.01 Fault 1	Fault Register 1 (the most current record)	Fault name (read only)		Read only
90.02 Time 1	Register of time of occurrence of fault from Fault register 1	Time (read only)		Read only
...				
90.63 Fault 32	Fault Register 32 (the oldest record)	Fault name (read only)		Read only
90.64 Time 32	Register of time of occurrence of fault from Fault register 32	Time (read only)		Read only
Group 97 – VSD service parameters				
97.39	Result Ia	<i>Service parameter</i>		
97.40	Result Ib	<i>Service parameter</i>		
97.41	Result Ic	<i>Service parameter</i>		
97.42	Result Ua	<i>Service parameter</i>		
97.43	Result Ub	<i>Service parameter</i>		
97.44	Result Uc	<i>Service parameter</i>		
97.45	Result UDC	<i>Service parameter</i>		
97.48	AutoOffset Trig	<i>Service parameter</i>		
97.49	LoadDefault VSD	<i>Service parameter</i>		
97.50	Scale Ia1	<i>Service parameter</i>		
97.51	Offset Ia1	<i>Service parameter</i>		
97.52	Scale Ia2	<i>Service parameter</i>		

Parameter / Name	Function	Available options / measurement unit	Factory setting	Change during operation
97.53	Offset Ia2	<i>Service parameter</i>		
97.54	Scale Ib1	<i>Service parameter</i>		
97.55	Offset Ib1	<i>Service parameter</i>		
97.56	Scale Ib2	<i>Service parameter</i>		
97.57	Offset Ib2	<i>Service parameter</i>		
97.58	Scale Ic1	<i>Service parameter</i>		
97.59	Offset Ic1	<i>Service parameter</i>		
97.60	Scale Ic2	<i>Service parameter</i>		
97.61	Offset Ic2	<i>Service parameter</i>		
97.62	Scale UDC1	<i>Service parameter</i>		
97.63	Offset UDC1	<i>Service parameter</i>		
97.64	Scale UDC2	<i>Service parameter</i>		
97.65	Offset UDC2	<i>Service parameter</i>		
97.66	Scale Ua	<i>Service parameter</i>		
97.67	Offset Ua	<i>Service parameter</i>		
97.68	Scale Ub	<i>Service parameter</i>		
97.69	Offset Ub	<i>Service parameter</i>		
97.70	Scale Uc	<i>Service parameter</i>		
97.71	Offset Uc	<i>Service parameter</i>		
Group 98 – AcR service parameters				
98.39	Result Ia	<i>Service parameter</i>		
98.40	Result Ib	<i>Service parameter</i>		
98.41	Result Ic	<i>Service parameter</i>		
98.42	Result Ua	<i>Service parameter</i>		
98.43	Result Ub	<i>Service parameter</i>		
98.44	Result Uc	<i>Service parameter</i>		
98.45	Result UDC	<i>Service parameter</i>		
98.48	AutoOffset Trig	<i>Service parameter</i>		
98.49	LoadDefault AcR	<i>Service parameter</i>		
98.50	Scale Ia1	<i>Service parameter</i>		
98.51	Offset Ia1	<i>Service parameter</i>		
98.52	Scale Ia2	<i>Service parameter</i>		
98.53	Offset Ia2	<i>Service parameter</i>		
98.54	Scale Ib1	<i>Service parameter</i>		
98.55	Offset Ib1	<i>Service parameter</i>		
98.56	Scale Ib2	<i>Service parameter</i>		
98.57	Offset Ib2	<i>Service parameter</i>		
98.58	Scale Ic1	<i>Service parameter</i>		
98.59	Offset Ic1	<i>Service parameter</i>		
98.60	Scale Ic2	<i>Service parameter</i>		
98.61	Offset Ic2	<i>Service parameter</i>		
98.62	Scale UDC1	<i>Service parameter</i>		
98.63	Offset UDC1	<i>Service parameter</i>		
98.64	Scale UDC2	<i>Service parameter</i>		
98.65	Offset UDC2	<i>Service parameter</i>		
98.66	Scale Ua	<i>Service parameter</i>		
98.67	Offset Ua	<i>Service parameter</i>		
98.68	Scale Ub	<i>Service parameter</i>		
98.69	Offset Ub	<i>Service parameter</i>		
98.70	Scale Uc	<i>Service parameter</i>		
98.71	Offset Uc	<i>Service parameter</i>		

TWERD ENERGO-PLUS sp. z o.o.

ul. Aleksandrowska 28-30
87-100 Toruń, Poland

tel. +48 56 654-60-91
e-mail: twerd@twerd.pl



www.twerd.pl